

ABUSER'S MANUAL

BEFORE USING THE SHERMAN FILTERBANK, READ THE FOLLOWING

SAFETY INSTRUCTIONS

USE ONLY THE ORIGINAL ADAPTOR (OUTPUT 15V AC, 500mA) SUPPLIED WITH THIS MACHINE.
ALWAYS GRASP ONLY THE ADAPTOR WHEN PLUGGING INTO, OR UNPLUGGING FROM, AN OUTLET.

TRY TO PREVENT CORDS AND CABLES FROM BECOMING ENTANGLED.

ALSO, ALL CORDS AND CABLES SHOULD BE PLACED SO THAT THEY ARE OUT OF THE REACH OF CHILDREN AND ANIMALS.

NEVER CLIMB ON TOP OF, NOR PLACE HEAVY OBJECTS ON THE UNIT.

NEVER HANDLE THE ADAPTOR OR ITS PLUGS WITH WET HANDS WHEN PLUGGING INTO, OR UNPLUGGING FROM, AN OUTLET OR THIS UNIT.

BEFORE MOVING THE UNIT, DISCONNECT THE ADAPTOR FROM THE OUTLET, AND PULL OUT ALL CORDS FROM EXTERNAL DEVICES.

BEFORE CLEANING THE UNIT, UNPLUG THE POWER AND UNPLUG THE ADAPTOR FROM THE OUTLET.

WHENEVER YOU SUSPECT THE POSSIBILITY OF LIGHTNING IN YOUR AREA, PULL THE PLUG ON THE ADAPTOR OUT OF THE OUTLET.

BEFORE USING THIS UNIT, MAKE SURE TO READ THE INSTRUCTIONS, AND THE USER'S MANUAL.

DO NOT OPEN OR PERFORM ANY INTERNAL MODIFICATIONS ON THE UNIT. (THE ONLY EXCEPTION WOULD BE WHERE THIS MANUAL PROVIDES SPECIFIC INSTRUCTIONS WHICH SHOULD BE FOLLOWED IN ORDER TO MAKE INTERNAL ADJUSTMENTS.)

WHEN USING THE UNIT WITH A RACK OR STAND, THE RACK OR STAND MUST BE CAREFULLY PLACED SO IT IS LEVEL AND SURE TO REMAIN STABLE. IF NOT USING A RACK OR STAND, YOU STILL NEED TO MAKE SURE THAT ANY LOCATION YOU CHOOSE FOR PLACING THE UNIT PROVIDES A LEVEL SURFACE THAT WILL PROPERLY SUPPORT THE UNIT, AND KEEP IT FROM WOBBLING.

AVOID DAMAGING THE ADAPTOR CORD. DO NOT BEND IT EXCESSIVELY, STEP ON IT, PLACE HEAVY OBJECTS ON IT, ECT. A DAMAGED CORD CAN EASILY BECOME A SHOCK OR FIRE HAZARD. NEVER USE AN ADAPTOR AFTER IT HAS BEEN DAMAGED, REPLACE IT.

WITH SMALL CHILDREN : AN ADULT SHOULD PROVIDE SUPERVISION UNTIL THE CHILD IS CAPABLE OF FOLLOWING ALL THE RULES ESSENTIAL FOR THE SAFE OPERATION OF THE UNIT.

PROTECT THE UNIT FROM STRONG IMPACT. (DO NOT DROP IT!)

DO NOT FORCE THE UNIT'S ADAPTOR TO SHARE AN OUTLET WITH AN UNREASONABLE NUMBER OF OTHER DEVICES. BE ESPECIALLY CAREFUL WHEN USING EXTENSION CORDS - THE TOTAL POWER USED BY ALL DEVICES YOU HAVE CONNECTED TO THE EXTENSION CORD'S OUTLET MUST NEVER EXCEED THE POWER RATING (WATTS / AMPERES) FOR THE EXTENSION CORD. EXCESSIVE LOADS CAN CAUSE THE INSULATION ON THE CORD TO HEAT UP AND EVENTUALLY MELT THROUGH.

BEFORE USING THE UNIT IN A FOREIGN COUNTRY, CONSULT WITH YOUR DEALER, OR QUALIFIED SHERMAN PERSONNEL.

BEFORE YOU START

MAKE SURE THE ADAPTER VOLTAGE COMPLIES WITH THE VOLTAGE OF YOUR AC POWER SUPPLY
AVOID EXCESSIVE FORCE ON THE JACK CONNECTIONS OR KNOBS
BE CAREFUL WITH YOUR SPEAKERS AT HIGH VOLUMES
THE FILTERBANK CAN PRODUCE EXTREMELY LOW FREQUENCIES
READ THE SAFETY INSTRUCTIONS

PREFACE ON VERSION 2

First of all, I want to thank everybody who appreciated and bought the original FB. All the positive feedback is a welcome support that encourages us to carry on. On the filterbank 2 all over noise is reduced significantly, not removed. Some die-hard old FB freaks will regret the loss of this lo-fi, others will hear different new things. I'm tired of defending the noise behaviour of the filterbank. Every newer design has its own specific sound, which is to my feeling the best so far with this kind of technology to use in music. My definition of "music" is very personal, but nevertheless everybody that considers buying the sfb2, should know by now that a clean 24-bit DSP filter nor any plug-in has anything in common with this dirty hardware box. E.g. it is normal that filter 2 produces more clock noise than filter 1 in the low freq settings. As with the model before, filter2 has more resonance than filter1.

FCC WARNING

This equipment generates, uses and can radiate radio frequency energy, and if not installed and used in accordance with the instructions manual, may cause interference to radio communications. It has been tested and found to comply with the limits for Class A computing device pursuant to Subpart J of Part 15 FCC Rules, (according to EN 55103-1 standard) which are designed to provide reasonable protection against such interference when operated in a commercial environment. Operation of this equipment in a residential area is likely to cause interference, in which case the user at his own expense will be required to take whatever measures may be required to correct the interference.

INTRODUCTION

WHAT IS THE FILTERBANK AND WHAT CAN YOU USE IT FOR?

It is a versatile filter effect box with tube sound overdrive, 12 parameters of it are MIDI controllable. Any sound source, live or in studio can be used, but it's obvious that you won't get far without an external sound source. It's a smart decision to buy this thing, because it is not based on processor calculation speed, it will keep its value for many years.

APPLICATIONS INCLUDE:

- Live performance of music & dj's.
- Expansion module for modular synthesizer systems.
- Mix effect or specialised equalisation in studio.
- Enhancement of dull sounding digital gear.
- Guitar overdrive effect box...

ALL SOUND SOURCES ARE USABLE ON THE INPUT, E.G.:

Synth / Sampler / Guitar / Bass Guitar / Microphone / CD Player / Any headphone output (those are often free and accessible)
Drummachine / Effect Send / Rhodes Piano / Hammond Organ / Saxophone.....

This is a crash course for all you musicians who hate wasting time reading manuals. However, it's a good idea to understand the actual function of a certain knob in order to produce a sound that you have total control over. It is easier than it looks, don't worry. The sherman filterbank (FB from now on) is a musical instrument you need to practice with if you want to release its full potential. Soon you will find the FB an excellent and reliable live instrument.

The 11 lessons in this booklet must be performed one by one, only skipping to the next one if you feel fully familiarized with it. But in fact, lesson 1 to 8 is all you need to start working.

As a beginner it's better to skip the 🎧 parts. Note there is no power-on switch. The FB consumes less power than an average answering machine, and most music set-ups & studios have a general power switch.

TABLE OF CONTENTS

0	START	6	8	AM - AMPLITUDE MODULATION....	38
1	BASICS - EXPLORING FILTER 1	8	9	TRANPOSE - TRACKING	40
2	SYNC MODE - FILTER 2	12	10	EXTERNAL INPUTS	42
3	OUT 1 - COMBINING THE TWO FILTERS...	14	11	MIDI	44
4	LFO - LOW FREQUENCY OSCILLATOR	20	12	LINKING MORE FILTERBANKS.....	52
5	AR - VOLUME MODULATION GENERATOR	22		HISTORY & PHILOSOPHY	54
6	ADSR - ENVELOPE FOLLOWER	24		TROUBLESHOOTING.....	56
7	FM - FREQUENCY MODULATION	36		MEMORY NOTATION SHEET	57



Warning



Tip



Caution



Idea



Trick



Important



Repeat

START

ABOUT THESE LESSONS...

Make yourself comfortable with this manual in front of you, your setup and the FB powered on. Set all knobs as indicated on the front panel drawings whenever it is required in a lesson. Feed a signal source to the input, e.g. a synth or a sampler. Connect the main output to your sound system. Notice the knob in the right top corner called **BYP <> EFF**, it sets the balance between the incoming signal and the processed signal. Using this knob you can always compare the original signal with the processed signal. Turn it completely clockwise during the lessons.



If no sound appears, check your input signal source, jack cables, make sure the trigger indicating lights are working, set the attack on the AR generator to zero and adjust the frequencies. Didn't you send a MIDI volume message? It can mute the outputs.

On the website www.sherman.be you can find a section "**manual sound examples**" as well as an illustrative video.

ABOUT THE KNOB COLOURS...

	COLOUR	RELATES TO
	blue	Filter frequency
	yellow	ADSR generator
	green	Volume
	orange	Resonance/Power
	white	Balance
	red	Anti-phase correction

figure 1

RACK MOUNTING

The 2 rack mount hooks can be screwed on the sides of the unit as shown here. Leave some space above the unit or put on top, in order to reach the connections on the back.

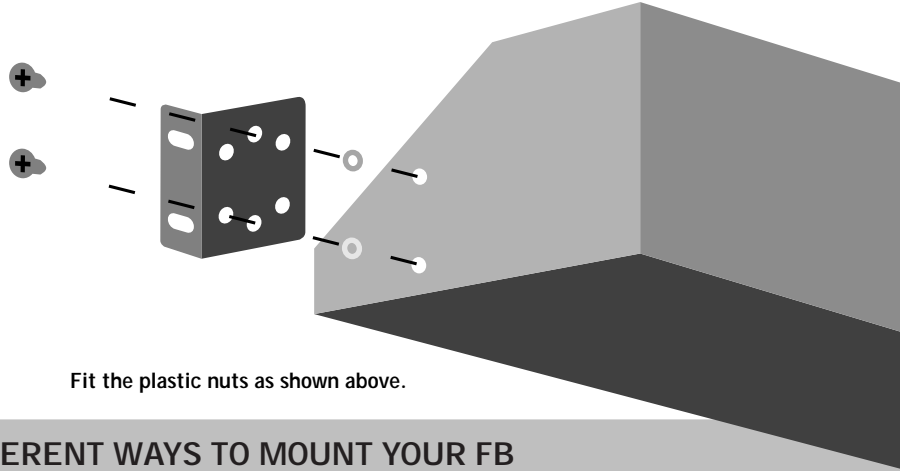

Fit the plastic nuts as shown above.

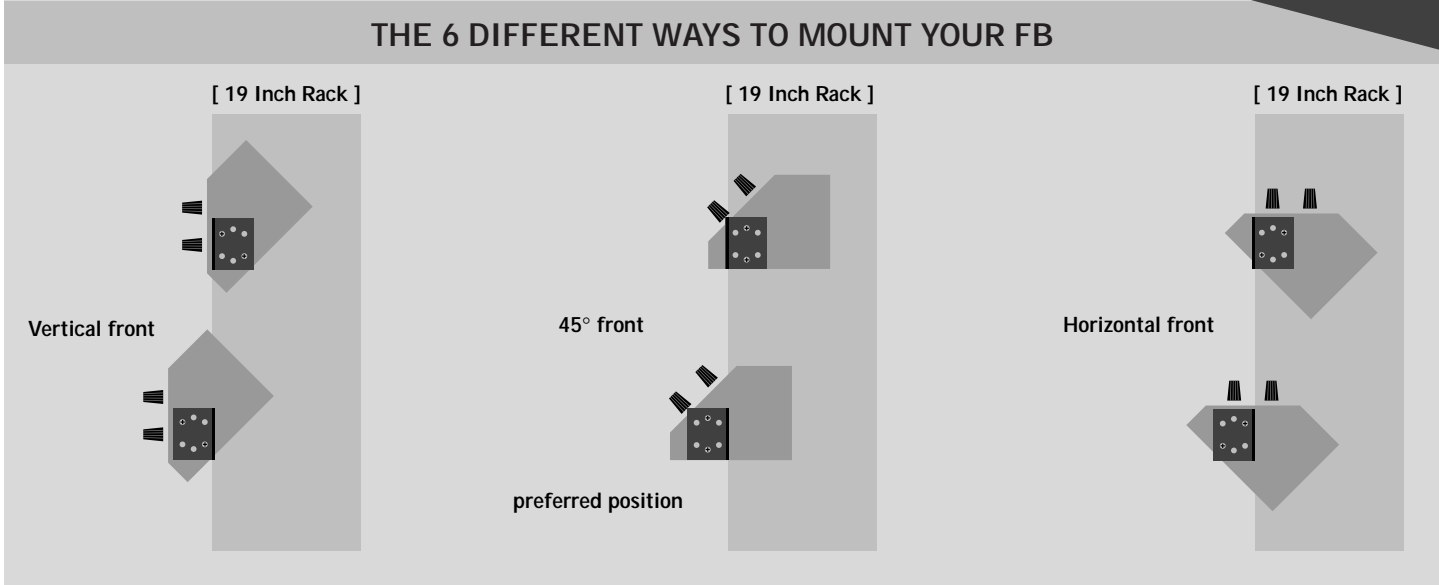

LESSON #1

BASICS - EXPLORING FILTER 1

Send a continuous signal from the signal source (e.g. a sawtooth wave or a similar sound containing enough high harmonics) to the input jack. Connect only the main output to your sound system.

 Don't turn your sound system up to its maximum volume yet.

Turn up the INPUT level just high enough to make BOTH trigger indicating lights react to the signal source. When a continuous tone enters the FB, these lights must light up continuously too (fig.2).

Now look at fig. 3 and set the marked knobs to the indicated positions. Start getting familiar with the following knobs :

- 1) Frequency (see also page 10 )
- 2) Resonance
- 3) Low pass / Band pass / High pass (fig.4)
- 4) The correction knob :
 - Band pass / 0 / - Band pass + Low pass & High pass (fig.4)

The idea behind this knob was to overcome the limitations of the Lp/Bp/Hp balance knob. You may ask yourself : why not three knobs, one for Lp, one for Bp and one for Hp? Simple: suppose you turn the Lp/Bp/Hp balance knob quickly from left to right and back. Now imagine trying to achieve the same effect with three separate knobs...

 Beginners can leave this correction knob in the 0 (mid) position. now set Lp/Bp/Hp on Bp (mid) position. Try to minimize the filter 1 output by turning the correction knob to the left. This way you can turn down the filter output to almost zero, because a simple calculation learns that $Bp - Bp = 0$!

When you turn the knob to $-Bp+HpLp$ and turn down reso, the same as above happens with the Bp; it is turned to zero, but now Lp+Hp are present, making a so called NOTCH filter. Changing the frequency provides a kind of phasing effect. This notch filter can be used for suppressing a very small part of the frequency range, e.g. an ugly harmonic in a snare drum, or even hum.

figure 2

HOW AUDIO TRIGGERING WORKS

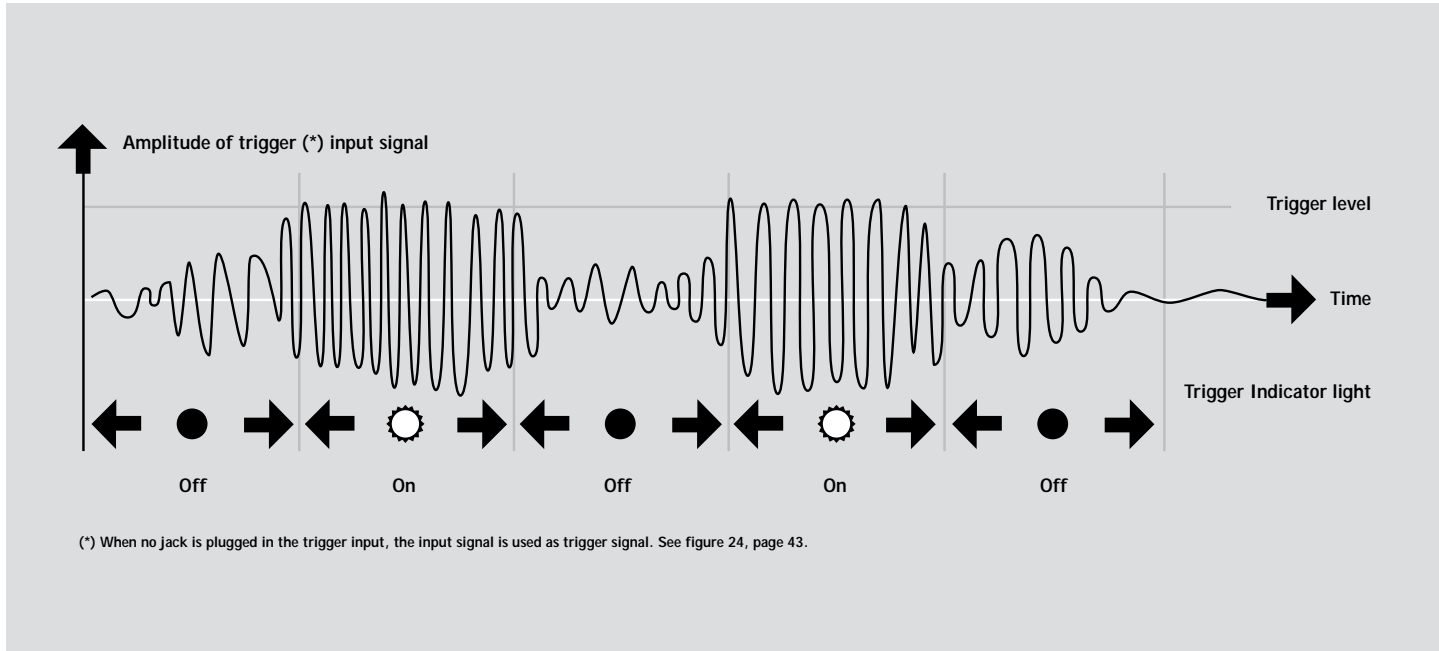

Suppose you want all frequencies to pass ($Lp + Bp + Hp$): set the Lp Bp Hp balance on Bp and the correction knob halfway $-Bp + LpHp$. This gives following calculation :

$$\begin{aligned} & Bp + 0.5(-Bp + Lp + Hp) \\ = & Bp - 0.5Bp + 0.5Lp + 0.5Hp \\ = & 0.5Bp + 0.5Lp + 0.5Hp \\ = & 0.5(Bp + Lp + Hp) \end{aligned}$$

You can make up for the weaker output with more input.

 Fiddle around with these knobs until you know what to expect from them !

By turning the input level up, the sound will start to distort, with more harmonics being added at the input stage. Always remember that too much input can push away the resonance peaks, giving you the impression that the resonance knobs don't work properly. Try it out, it's one of the features you should be very familiar with; on the thin line between producing an over-the-top distorted racket and a noisy sound with low dynamics, the FB works best. It's up to you to find the right equilibrium.

Keep in mind that you always can adjust the balance between the processed signal and the original signal, or compare them with the Bypass-Effect knob.

The 3-way switch  on the input stage allows Hi boost (effective at low input level) as well as Hi cut effective at high input level)

The 3-way switch  allows "Sensitrig" (which makes the triggering twice as sensitive for, e.g. clean string pad filtering) and "Limit", which leaves the filters more "breathing room" for self-oscillation if the input stage is extremely overdriven.

 In low frequency settings, a weak high "eee" sound can occur.

This is perfectly normal and typical for the Filterbank.

Don't worry, it's not broken. It's mainly audible as as crossing over between both filters. When the harmonics switch is not in the "free" position, the "eee" sound in filter "1", caused by freq of filter "2" can be avoided by increasing the frequency of filter "2" a bit, as this filter "2" setting is not significant anyway.

If you want to work in this sub bass range, the "eeee" can be easily suppressed by turning down the hi eq on you mixing console.

LOWEST FREQUENCY RANGE

Our warning "Dangerous frequency range" is not a joke. Speaker coils can actually burn when they move too slow, and have lack of ventilation. This can happen at high volume and unhearable low frequency. The FB can easily produce frequencies below 1 Hz. The bottom frequency can change in different environment temperatures. This is a disadvantage of this analog system, the price to be payed for an extreme range. By inside adjustment, this bottom frequency can be changed. To do this, you must open the Filterbank and look for the trim holes marked "F1" an "F2". With a tiny screwdriver, you can re-adjust the bottom frequency of each filter to your needs. Please don't touch any other trim holes !

figure 3

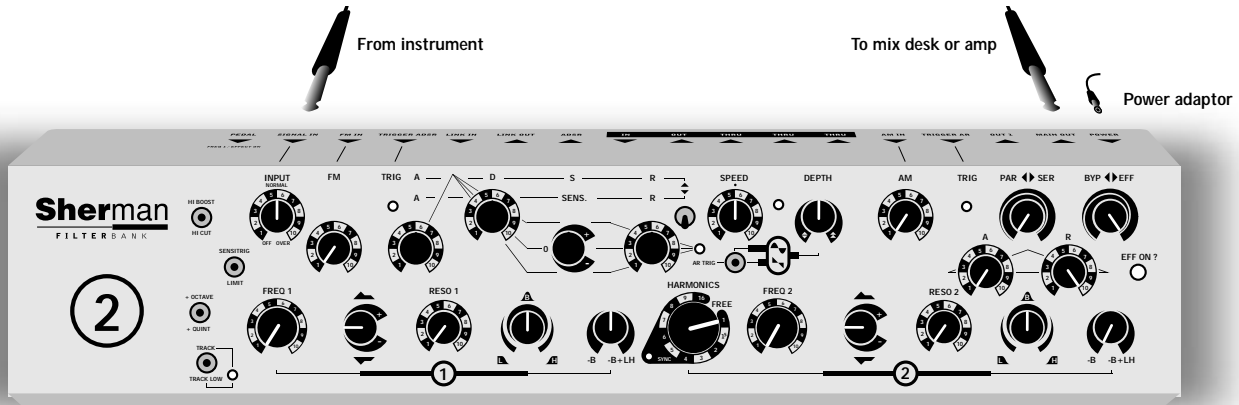
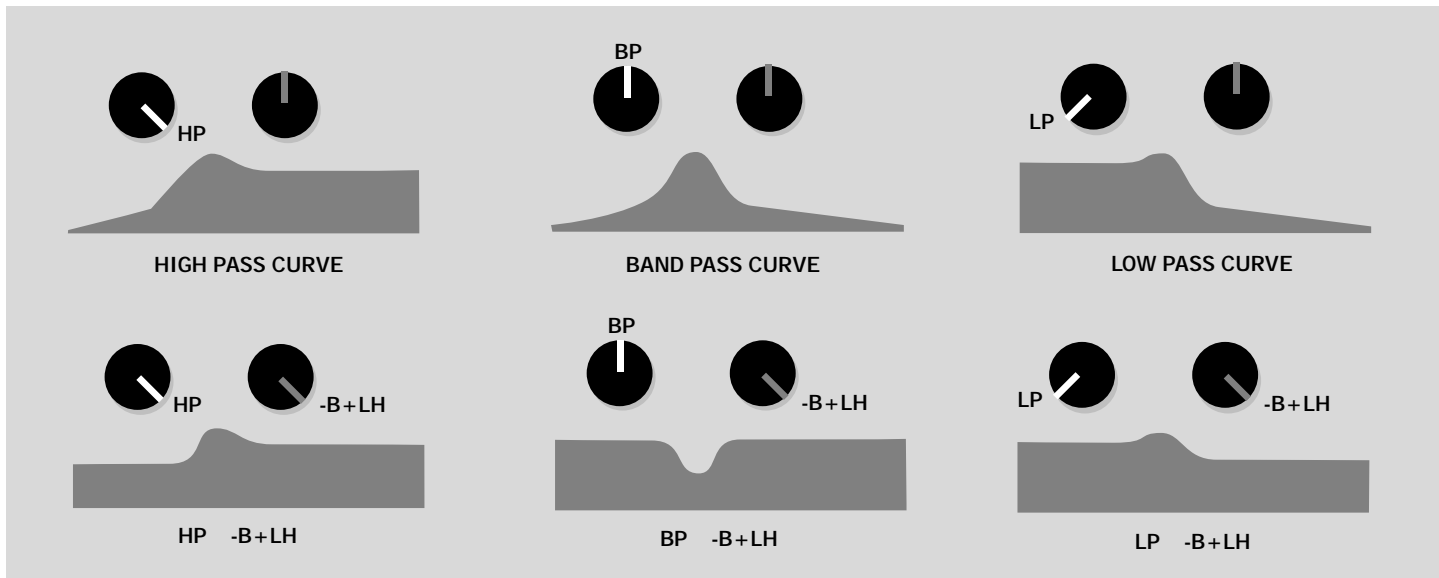

figure 4



LESSON #2

SYNC MODE - FILTER 2

Turn down the output of filter 1 (bp-bp). Set the PAR <> SER knob to par. Set the harmonics rotary switch to "free". Try out the settings of filter 2 ; it behaves in a similar way as filter 1. Now set the harmonics rotary switch to "1". The blue light will light up, indicating that filter 2 is in sync with filter 1. This means that the full frequency control of filter 2 is taken over by filter 1. In "sync" mode the frequency and ADSR amount knob of filter 2 have no function at all, and it's best to set them at minimum. (fig.5)

LEARNING HARMONICS:

Set reso filter 2 to maximum, select Bp and tune filter 2 (via the filter 1 frequency knob) so that a high tone resonance can be heard. Now check the lower harmonics by turning the rotary switch to the right. In order to get a better idea of these harmonics, mix filter 1 on too (correction knob at middle position, bp) with its resonance setting to maximum as well.

Check the harmonics once again and get familiar with the typical sound of the different harmonic intervals while sweeping with the freq 1 knob.

HARMONIC	FREQ 2=	MUSICAL:	DESCRIPTION:
free	freq 2	free	independent freq control
1	freq 1	c	equal tuning
1.5	f1 / 1.5	f 1	1 quint down
2	f1 / 2	c 1	1 octave down
3	f1 / 3	f 2	2 quints down
4	f1 / 4	c 2	2 octaves down
5	f1 / 5	g# 3	minor
6	f1 / 6	f 3	3 quints down
7	f1 / 7	d 3	2 semitones above 3 octaves down
8	f1 / 8	c 3	3 octaves down
9	f1 / 9	a# 4	2 semitones under 3 octaves down
16	f1 / 16	c 4	4 octaves down

see fig.6 for comparison with keyboard keys.



See also video on www.sherman.be

figure 5 **WHAT IS SYNC...**

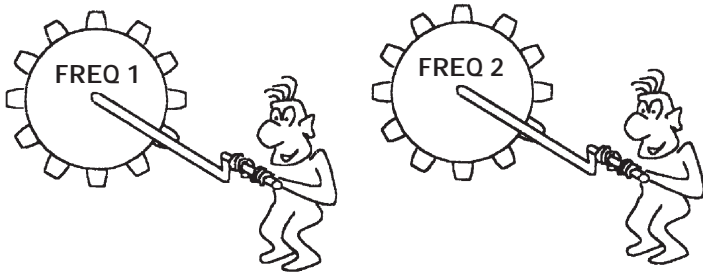

When the harmonic switch is in the "free" position, the two filters work independently.

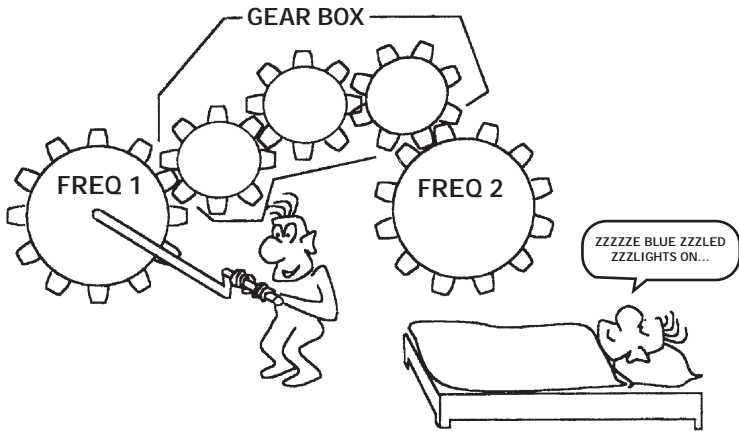

When the harmonic switch is in "SYNC", filter 1 controls filter 2 via the gear box, where you can choose 11 gears.

figure 6

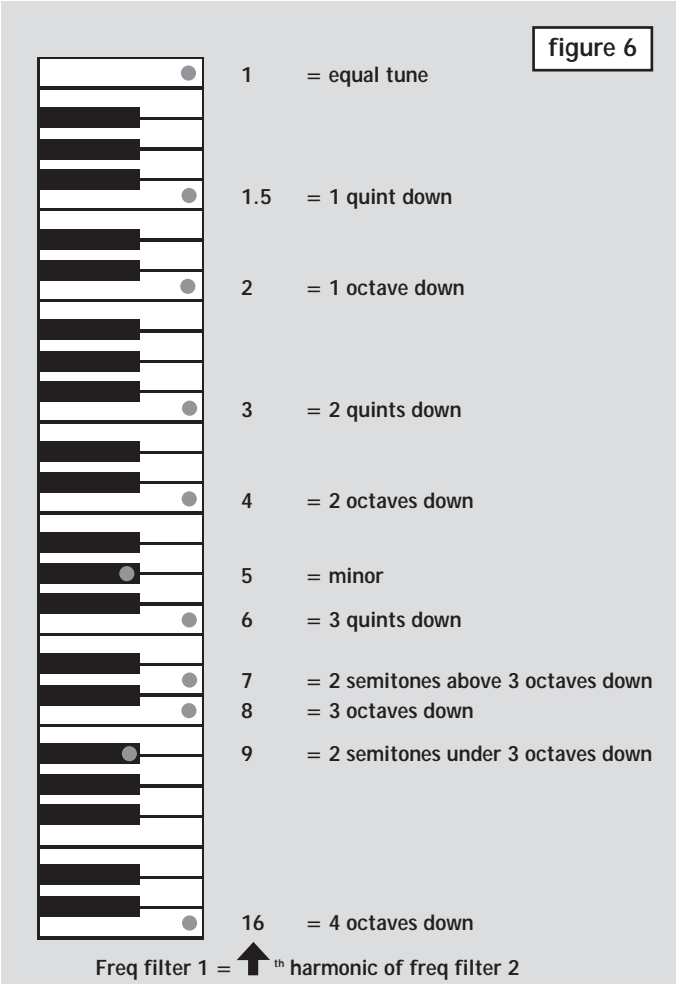

LESSON #3

OUT 1 - COMBINING THE TWO FILTERS

The difference between serial and parallel:

There are two fundamental ways to route the signal through the filters (fig.7):

PARALLEL:

Turn the PAR <> SER knob completely anti-clockwise. The input signal is fed directly to filter 1 and filter 2. The output of the two filters is mixed and fed through the main out VCA. If you connect a jack to the out 1 however, the output of filter 1 will disappear from the main output. In this case, the main out VCA only has filter 2 as input. The output of filter 1 always goes to out 1. This means that you can separate the output of the two filters completely. Check this out by connecting out 1 to your sound system as well and by panning OUT 1 and MAIN OUT vca in stereo.(fig.8) Now set the harmonics switch to "free" and toy around with the two filter frequencies. Try different resonance amounts as well as different harmonic switch settings.

SERIAL:

Turn the PAR <> SER knob completely clockwise. Disconnect the jack from OUT 1. The input signal goes to filter 1 only. The output signal of filter 1 goes to filter 2. Filter 2 goes to the MAIN OUT vca. Obviously, if one of the filters doesn't pass the signal on, nothing will appear at the MAIN OUT. If filter 1 and filter 2 are tuned equally (this is very easily done by setting filter 2 to sync mode "1") the filter effect is stronger. Two 12 db filters in series provide a 24 db filter (fig.9). Get familiar with the output combinations for both filters in serial mode. Start by using identical settings, e.g.

Lp 1 + Lp 2

Bp 1 + Bp 2

Lp 1 + Bp 1 + Lp 2 + Bp 2

Hp 1 + Hp 2

and so on... (fig.9)

Check these settings also with different reso positions. Now repeat these combinations with sync mode 1.5 (quint down). Try different reso settings and check the difference with parallel mode. No doubt you will find combinations giving poor results in serial mode, like Lp1 + Hp2. see figs 10, 11 and 12. There are so many filter curve possibilities that it's impossible to list them all, but what you should understand is why e.g. Hp 1 + Lp 2 in sync and in serial mode theoretically let no sound through: Because in sync freq 1 >= freq 2. This lesson never finishes, you can only get more experienced.

figure 7



figure 8 **MONO**
WHEN USING ONLY MAIN JACK

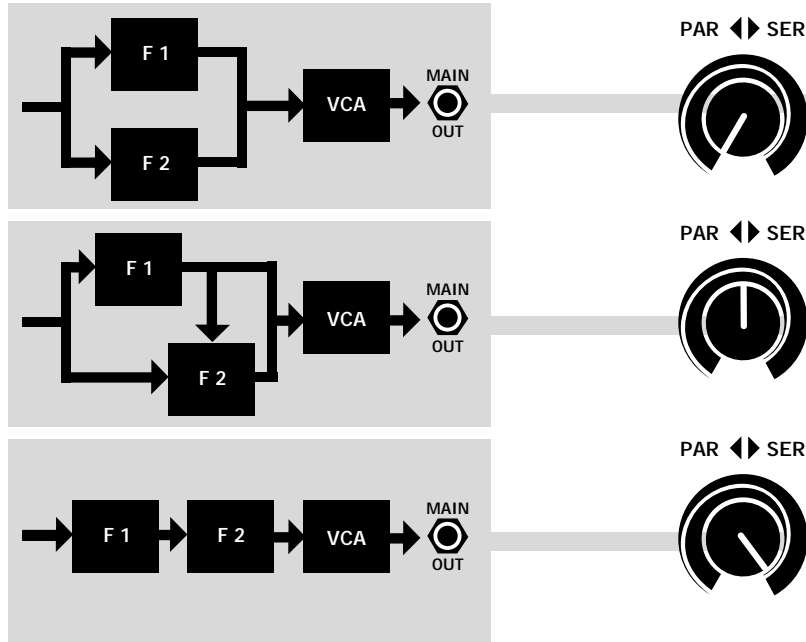

PSEUDO STEREO
WHEN A JACK IS PLUGGED IN OUT 1 AS WELL

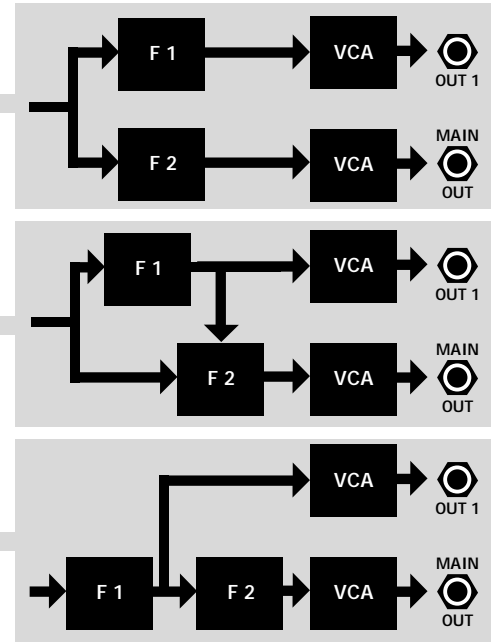

figure 9

FILTER CURVE, WHEN FREQ 1 = FREQ 2

MAIN OUT CURVE

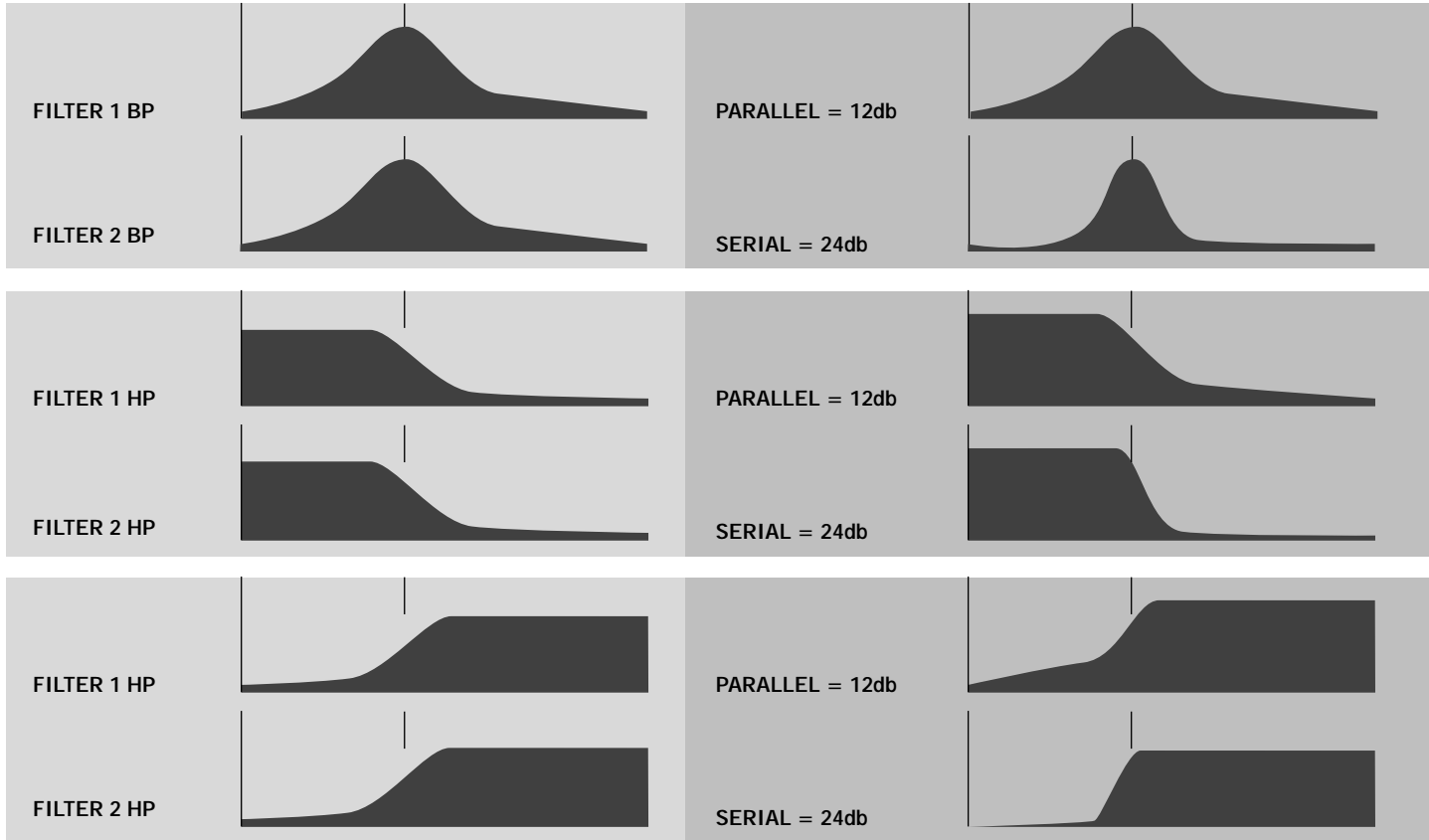
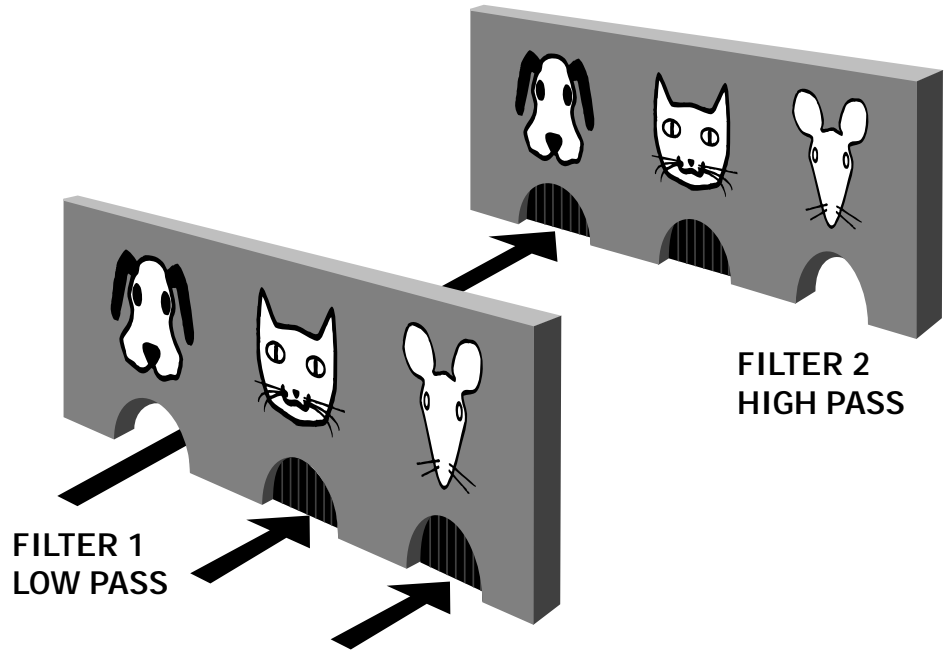
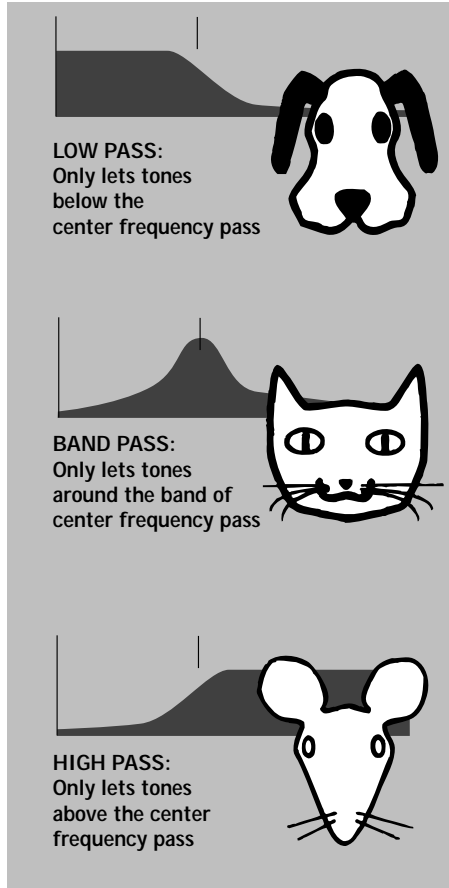

figure 10

SERIAL: IT'S IMPORTANT TO UNDERSTAND THIS!



This is an example of a situation where NO SIGNAL WILL COME OUT IN SERIAL, when the PAR<>SER knob is turned completely to SER (see figure 7), and when freq 2 is equal or higher than freq 1.

figure 11

THIS COMES NEARER TO REALITY!

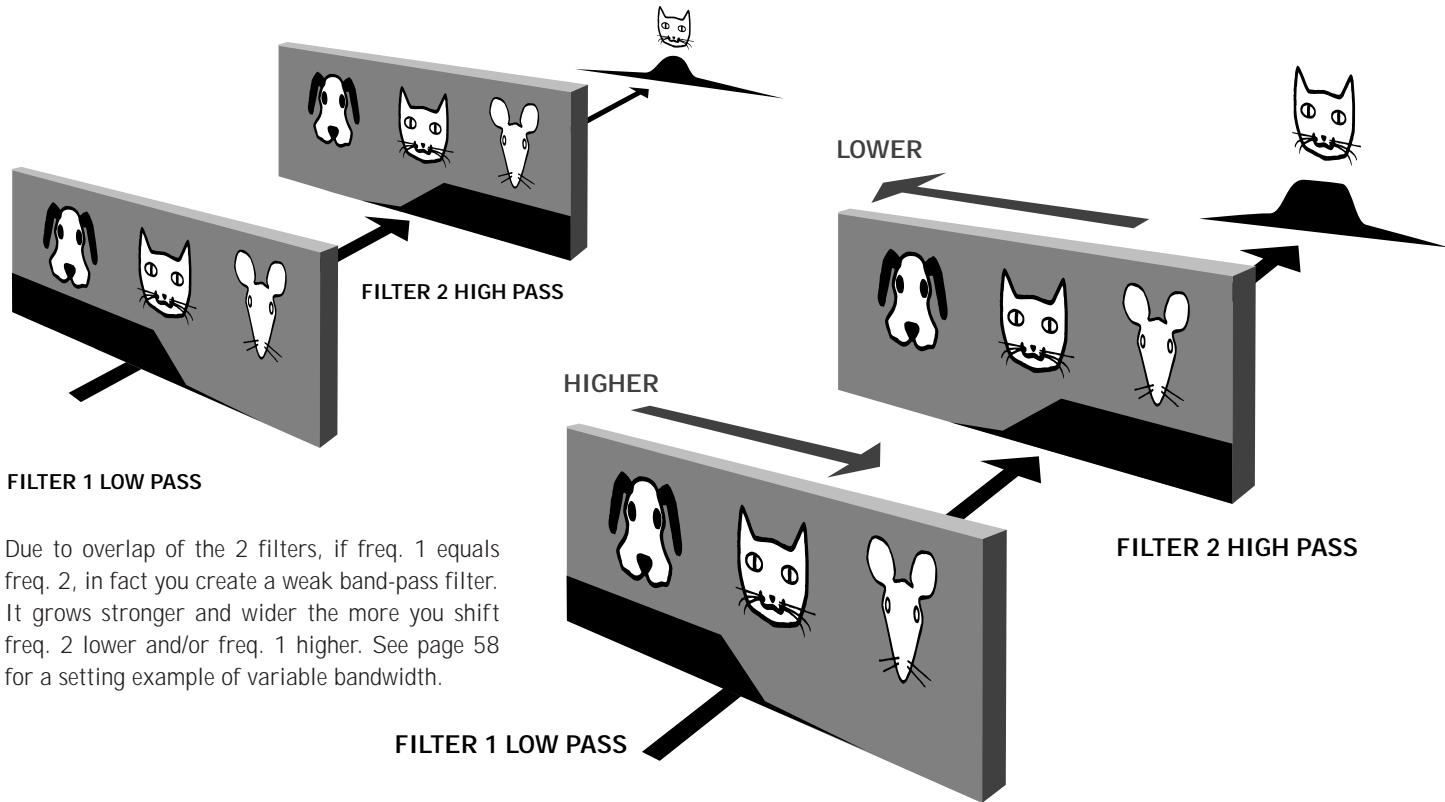

Due to overlap of the 2 filters, if freq. 1 equals freq. 2, in fact you create a weak band-pass filter. It grows stronger and wider the more you shift freq. 2 lower and/or freq. 1 higher. See page 58 for a setting example of variable bandwidth.

figure 12 PARALLEL

In PARALLEL, the signal of both filters is simply added. In the situation shown below, you create a small drop in the frequency range. It will become deeper and wider the more you make freq. 2 higher than freq. 1. Modulating such a drop, e.g. with the LFO amount knob to the right, will give a phasing-like effect. See page 58 for the setting example "PHASING 1"

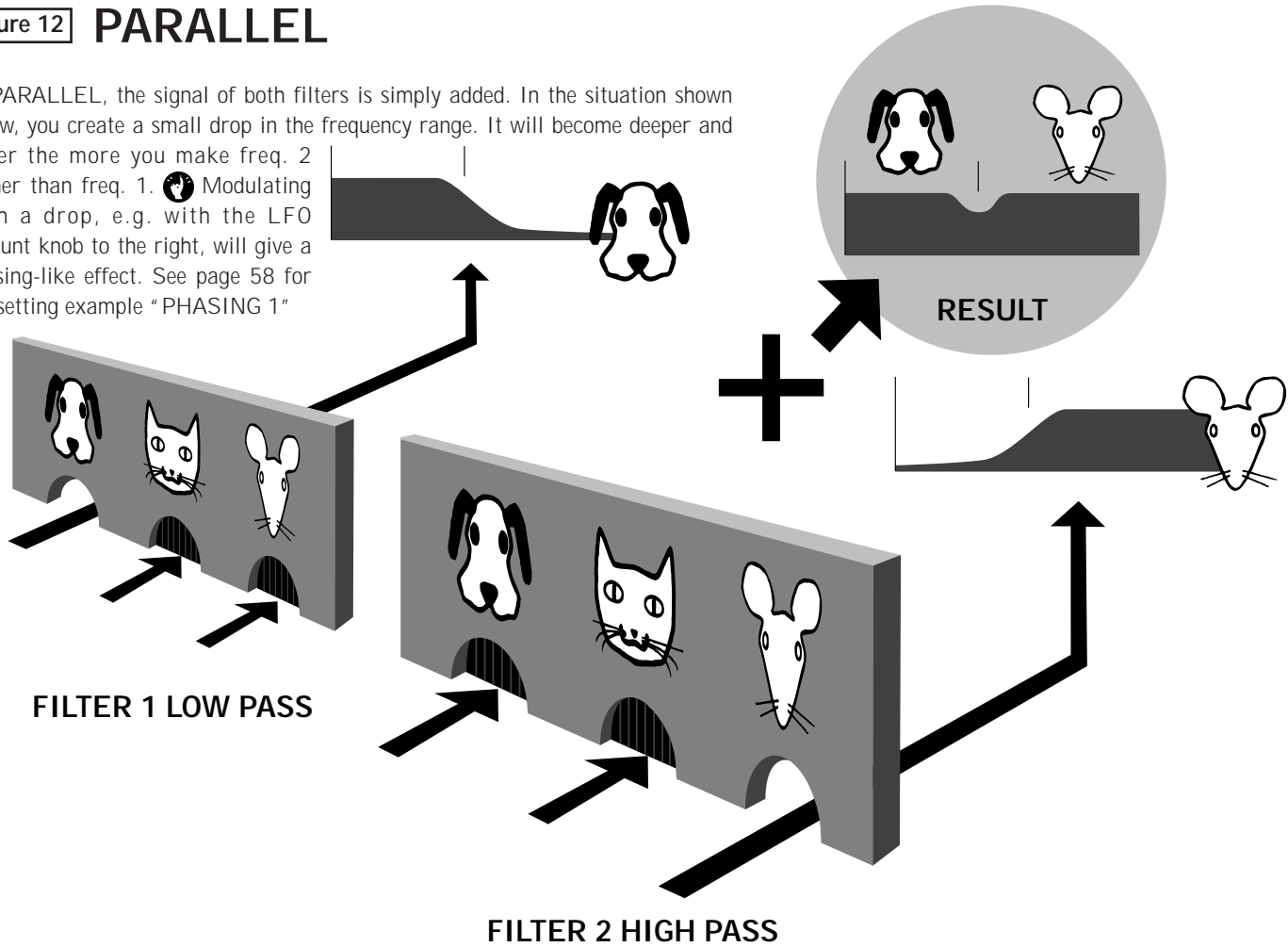

4

LESSON #4 LFO - LOW FREQUENCY OSCILLATOR

Feed a stable signal to the FB, e.g. organ, strings... Keep in mind that the trigger lights indicate when the FB is active. Connect out 1 and main out to your sound system, pan them in stereo and set the PAR <-> SER knob to parallel. Set the harmonics switch to "free" and filter 1 and filter 2 to high reso, around the same frequency. Now turn the LFO amount knob from zero to the right. Both filters should react equally to the LFO.

Notice the two colour indications of the LFO. This helps to locate the progression of very slow frequency waves. Check different LFO frequencies with the speed knob. From the left to the middle (click) position you get a normal LFO frequency range. From the middle (click) position to the right, the LFO becomes an audio range oscillator. Leave the LFO at a nice slow cycle frequency. Turn the LFO amount to the left - it will produce the opposite modulation for filter 1! (fig.13) try this with different LFO speed settings.

The LFO can be retriggered (restarted) over MIDI. Toggling from unblock audio trigger to block audio trigger restarts the LFO.

It works a bit random, which is an advantage, and occasionally can retrigger with very loud input; nothing to worry about. You do this by sending MIDI note C#4 preceded by C4, the notes that are also used for blocking and unblocking audio trigger of ADSR.

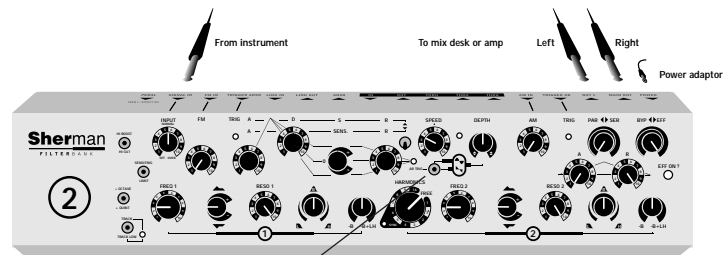

A 3-way function switch in the LFO section allows sawtooth wave shape or AR retriggering : this forces an LFO restart from the AR trig with pumping grooves as unavoidable result. Try this in low pass filter setting with LFO modulation.

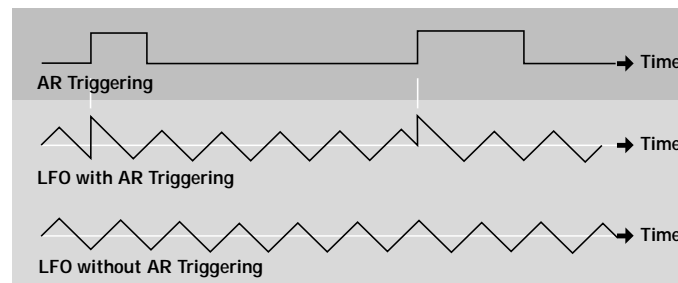
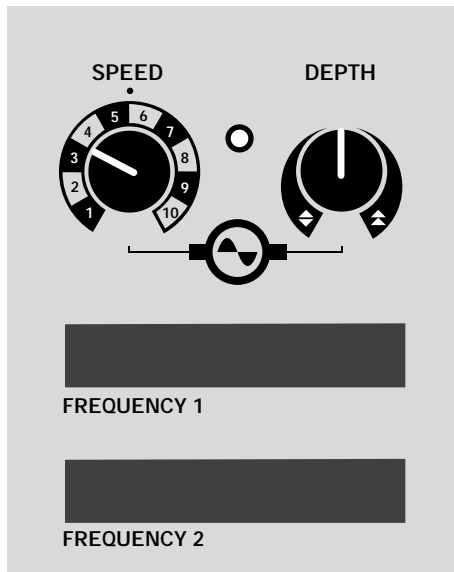
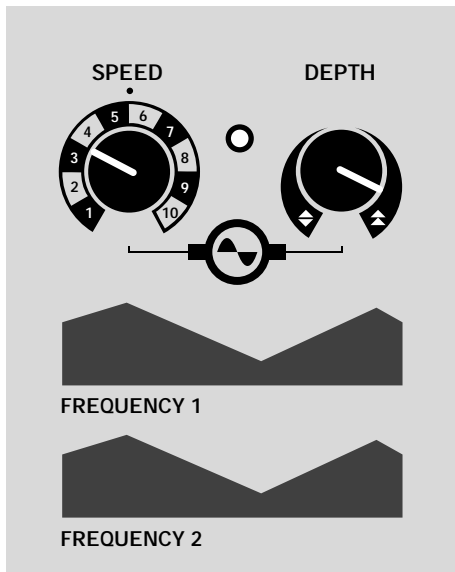
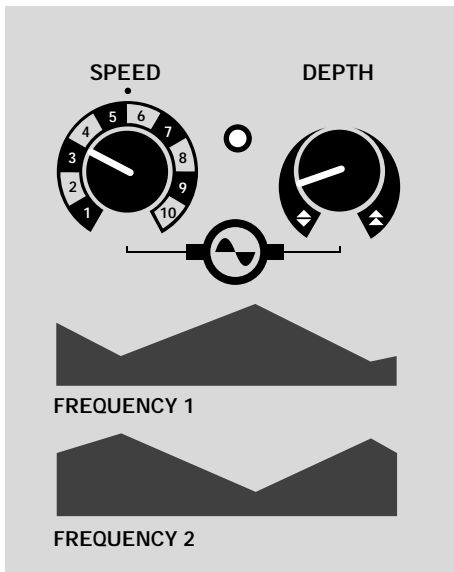

figure 13

HOW THE LFO DEPTH KNOB WORKS

EFFECT OF THE POSITION OF THE LFO DEPTH KNOB



LED COLOUR

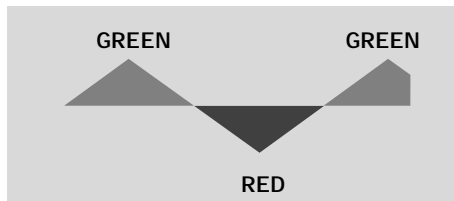
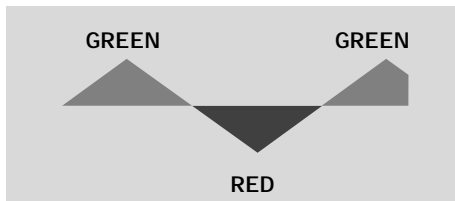
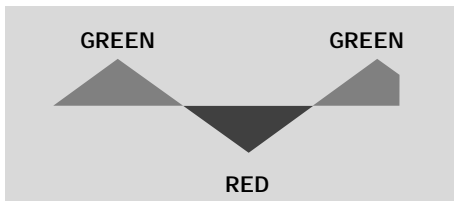

LESSON #5

AR VOLUME MODULATION GENERATOR

This generator equally controls the OUT 1 and MAIN OUT VCA's.

Play a sound with a slow attack, e.g. a string sound. Make sure that the ar trigger light goes on and off. Get familiar with the attack/release settings (starting from minimum) and with their influence on the output volume. You can also experiment with drum loops.

 Setting attack and release to minimum produces a rhythmic gating effect. By doing so you might experience a slight loss of attack (punch). This is because of the limited speed of the attack. You can speed up the attack by sending MIDI controller 5 value 0 to the FB. The default power-up value of controller 5 is 63 (= halfway 127). if this is not fast enough, record the AR triggers via MIDI and play them back with a slight amount of pre-delay.

TB303 TIP

 Here a way to achieve the sequencer behaviour of a Roland TB303, with MIDI. Make your source glide as you like to hear it on a track. Make a ghost copy track of that in your sequencer. Give a negative delay and another MIDI channel to that ghost track. Make e.g. a program on the main MIDI channel with the desired sound (square, sawtooth, polyphonic, whatever). Put this in the FB's ADSR or AR trigger input. Make a copy of that program on the ghost's MIDI channel. Put this signal in the FB audio input.

In case you have a CV out (e.g. SH101), connect it to FM in. This way you can obtain key-follow. Otherwise you can use envelope-follower as key-follow.

RESULT: The notes will start gliding to the next notes before the gate fully opens the VCA (also adjustable with pre delay, in smaller amount than the ghost track) and thus before the quantize of the song. A real bassplayer does similar things.

figure AR

OUTPUT AMPLITUDE IN FUNCTION OF AR KNOB POSITIONS

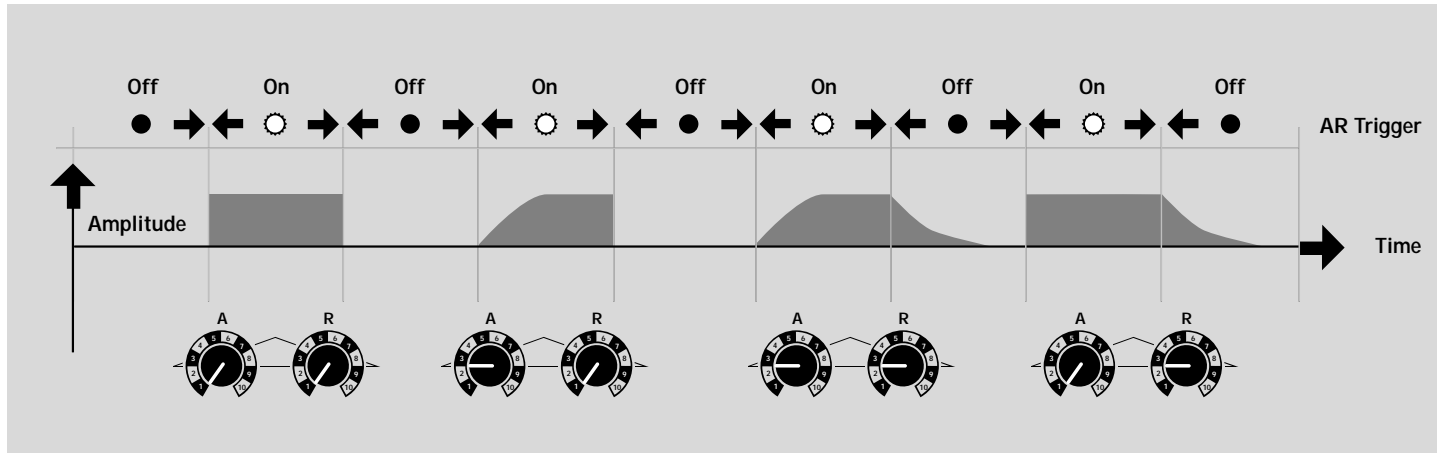

LESSON #6

ADSR**ADSR = ATTACK DECAY SUSTAIN RELEASE**

Set the toggle switch to ADSR (upward). Set harmonics to sync 1, filter 1 and filter 2 to max reso, serial mode, as shown in fig.14. Set the AR generator to zero attack and maximum release. Turn the envelope modulation knob of filter 1 slightly clockwise from the middle position. This way you have a high resonant filter that provides a clearly audible indication of the ADSR generator output. The bi-colour (yellow+ red-) light right next to the release knob always gives a visual indication of the ADSR generator's activity. Now slowly play the keyboard, or use a sequencer to have your hands free to explore the ADSR generator. Make sure the ADSR trigger light flashes in a slow and regular manner. Now, try out the following exercises : figs 15 to 21 SEQUENTLY !

🔄 Now repeat these exercises with different (+ and -) positions of the modulation amount knob of filter 1 (filter 2 is still in sync). Repeat these exercises with filter 2 "free" running in parallel mode; experiment also with the envelope modulation amount (+-) knob of filter2. At this point you should be familiar with the ADSR knobs.

ANOTHER EXERCISE:

Run a sixteenth note repetitive sequencer or arpeggio pattern with a short or percussive sound. Adjust the input level to make the ADSR trigger follow the sixteenth notes. Set the ADSR as in the last example in fig 21, page 32. Now try adjusting the attack time so that the ADSR indication light turns red with each sixteenth note. Slowly increase the attack time so that the ADSR generator misses every other trigger pulse. The ADSR now makes an eight note cycle. Continue increasing the attack time slightly, so that it misses two out of three trigger pulses. This produces triplets. Repeat this exercise with e.g. a drum loop.

👁️ You can turn the ADSR generator into a second LFO by making a jack connection from LINK OUT to the ADSR trig in. Set freq 1 to zero, the ADSR amount of filter 1 to negative and the sustain to maximum. Using attack and release you can change the waveshape and speed. This "weird" LFO can be modulated with the normal LFO, MIDI pitch wheel, Unknown Control 5, and so on. The disadvantage is that filter 1 will go too low to be usable, unless you insert a volume pedal between LINK OUT and ADSR trig in.

figure 14

START
POSITION
FOR THE
ADSR
EXERCISES.

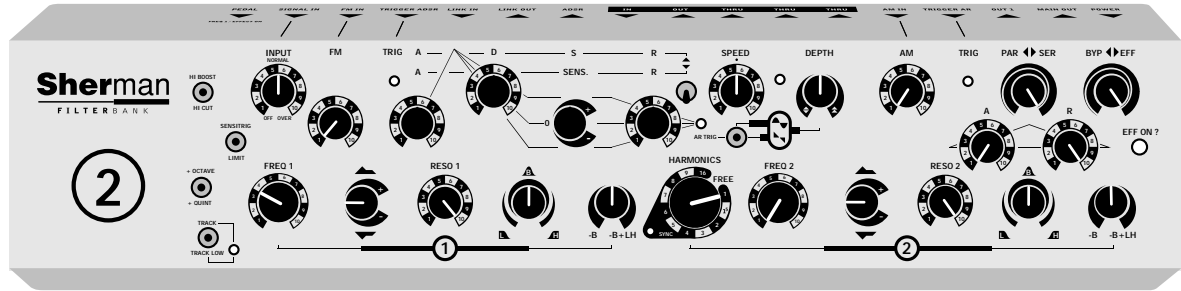

IN THIS GAME, YOU



ARE THE ENVELOPE OUT VOLTAGE

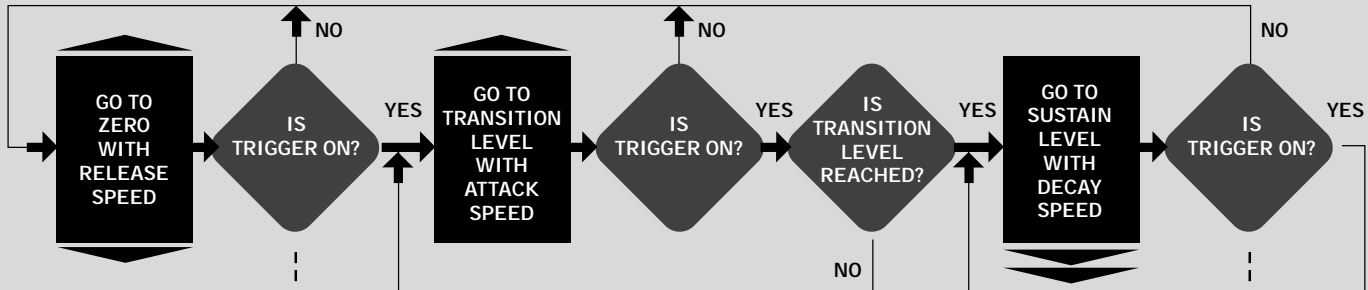

EXAMPLE

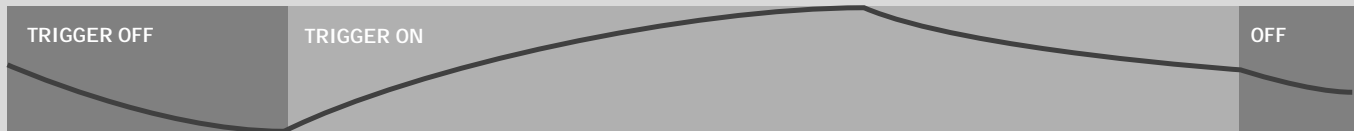



**START
HERE**

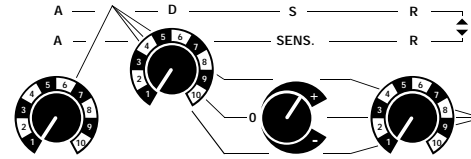
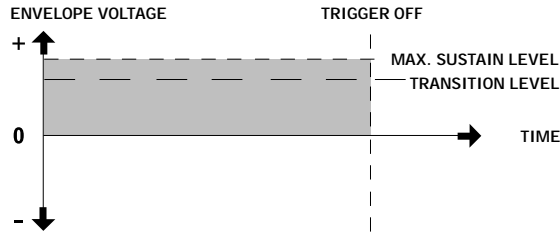

figure 15

Play the ADSR
really very slow
and see how it works

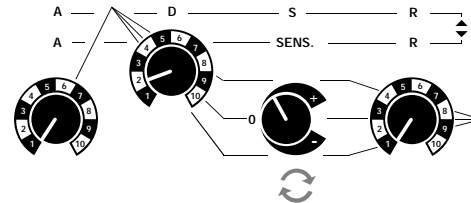
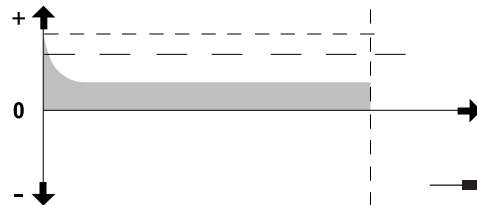
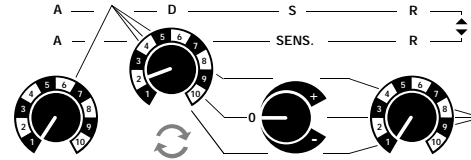
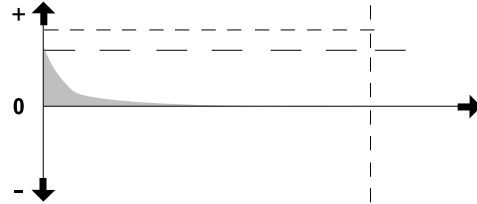
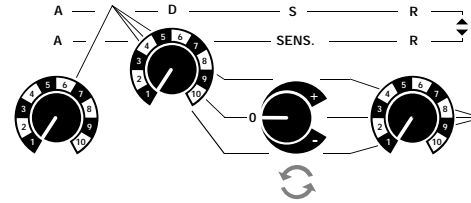
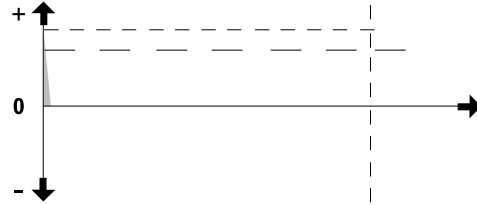

figure 16

= YELLOW

= RED

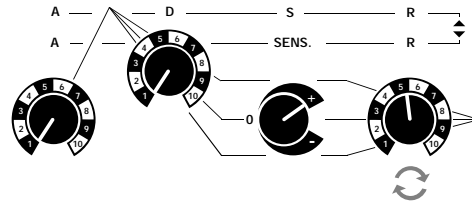
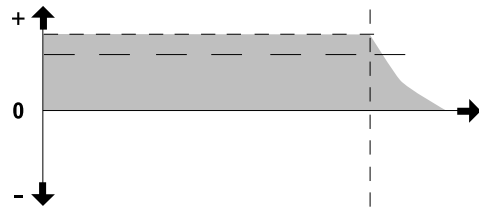
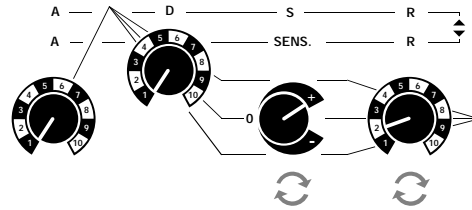
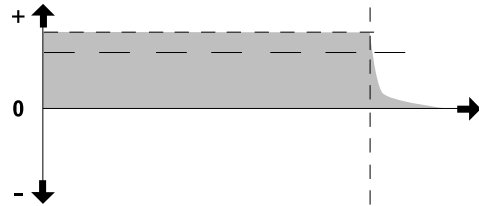
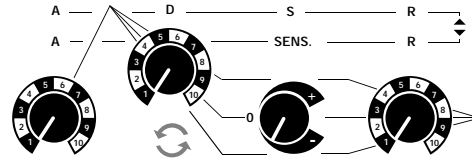
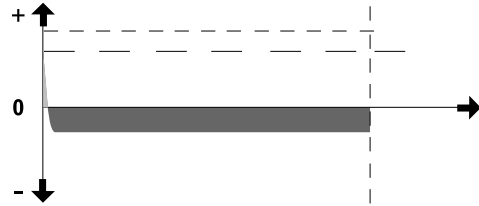
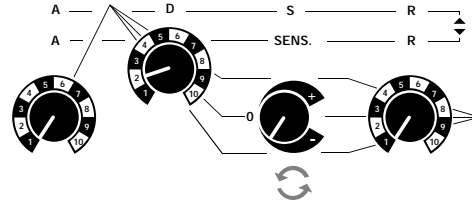
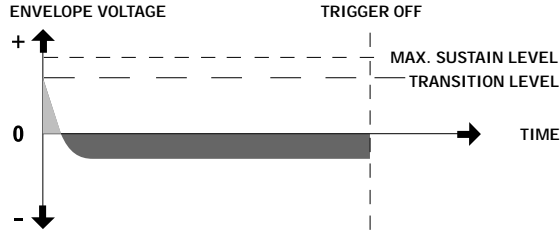

figure 17

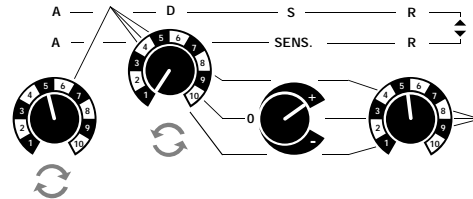
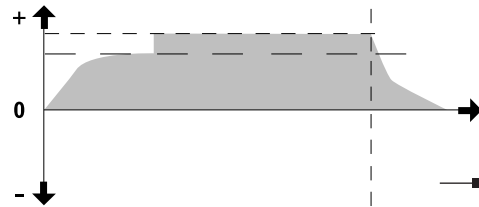
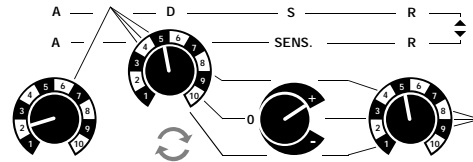
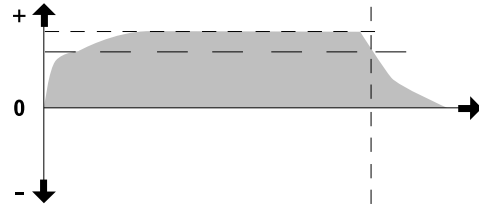
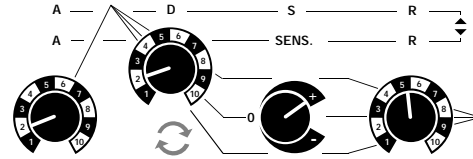
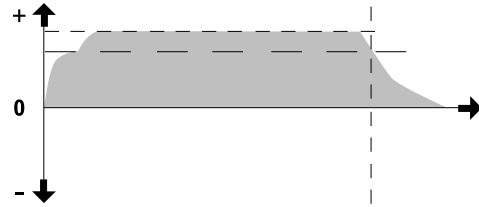
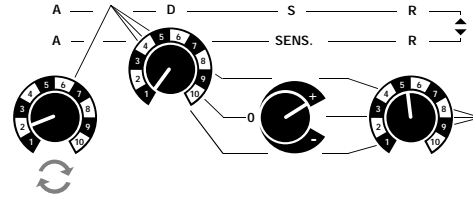
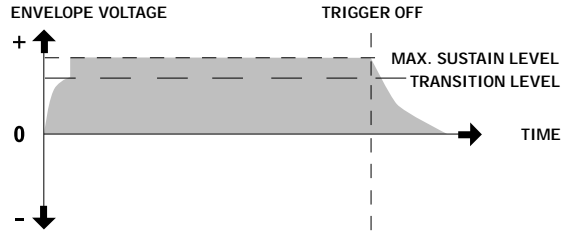

figure 18

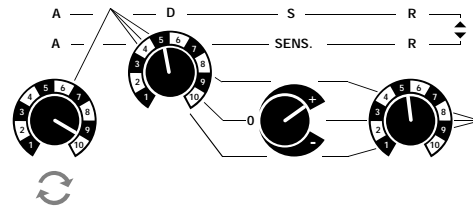
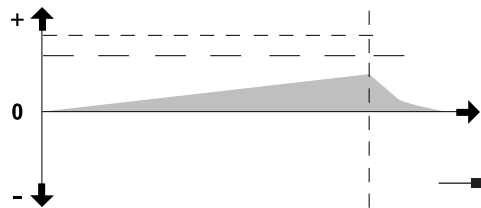
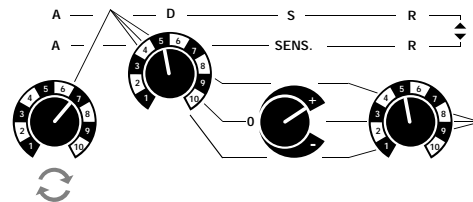
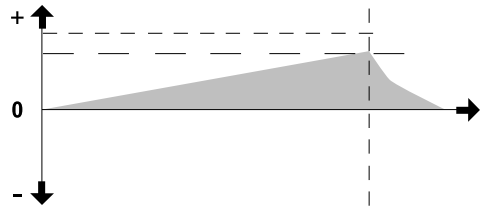
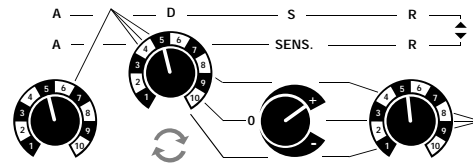
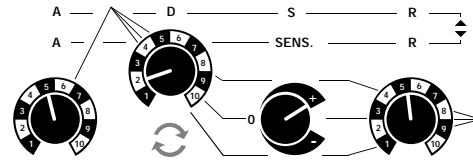
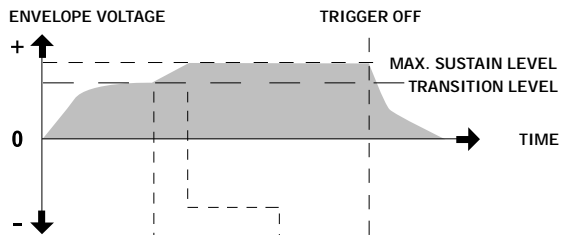
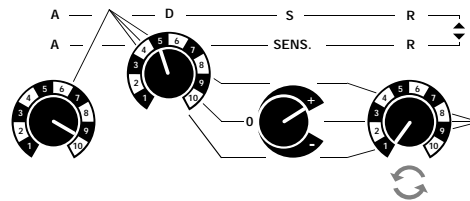
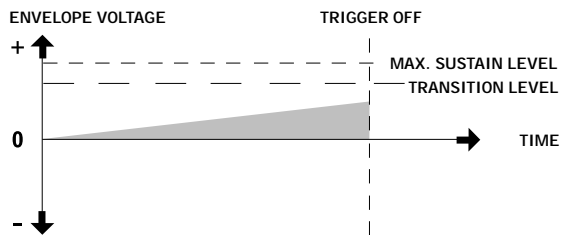

figure 19



Decay and sustain are changed, but won't play any role before the transition level is reached.

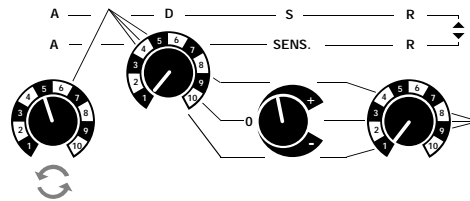
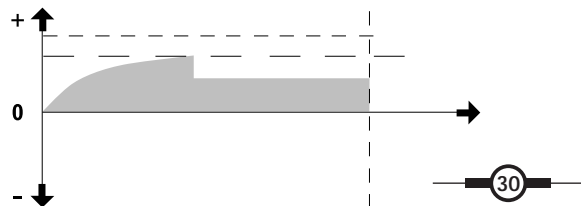
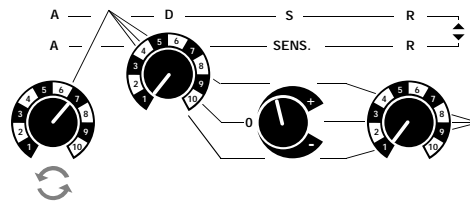
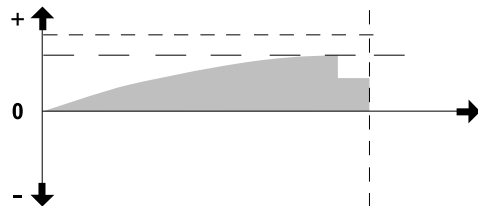
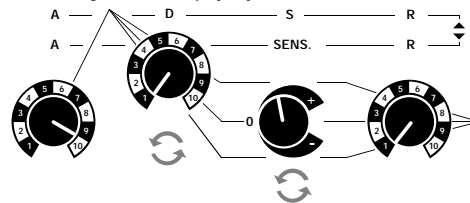
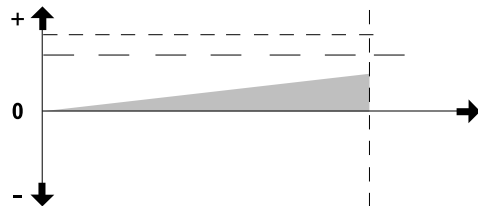

figure 20

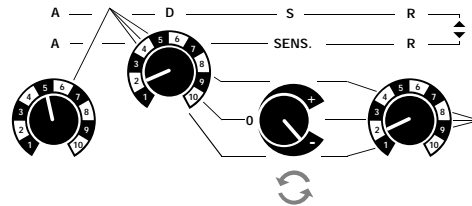
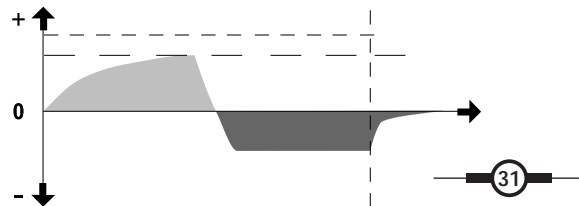
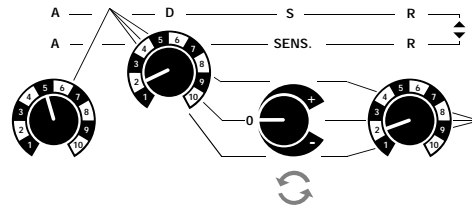
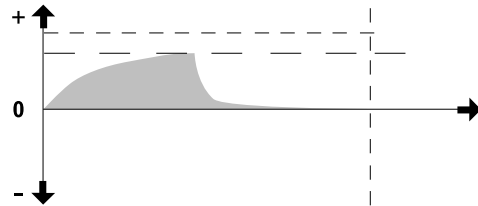
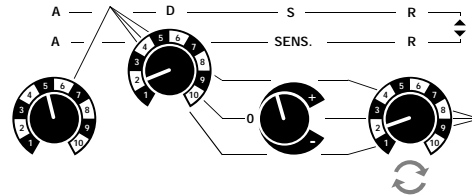
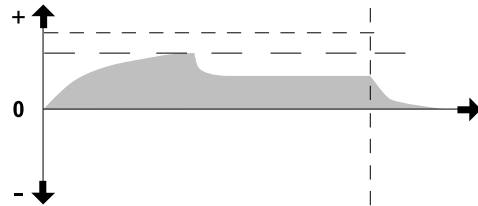
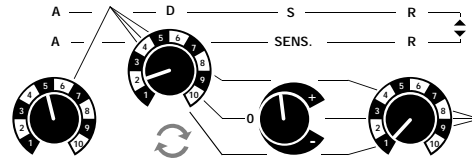
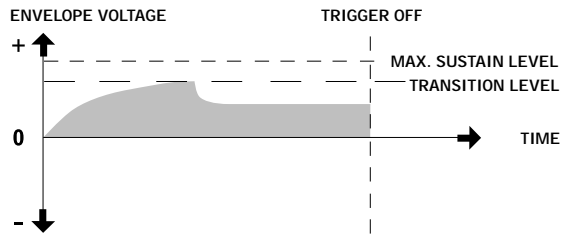
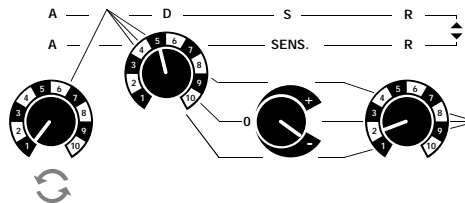
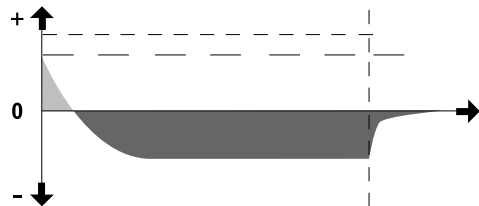
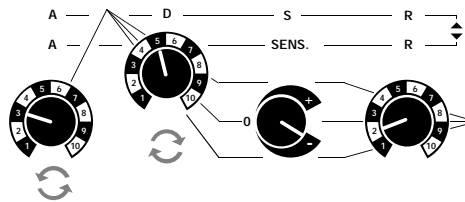
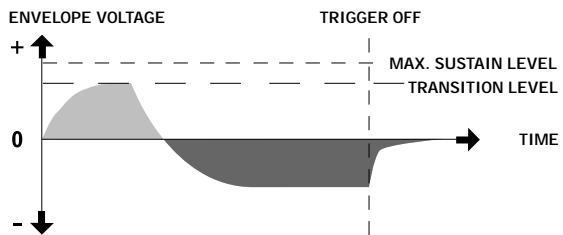

figure 21



LAST EXAMPLE

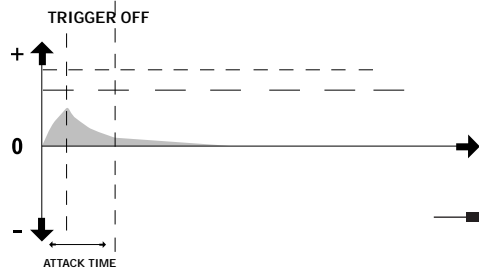
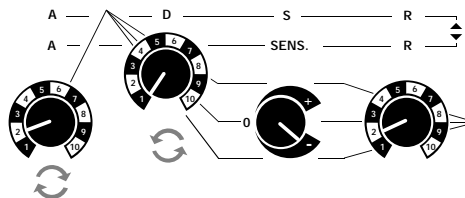
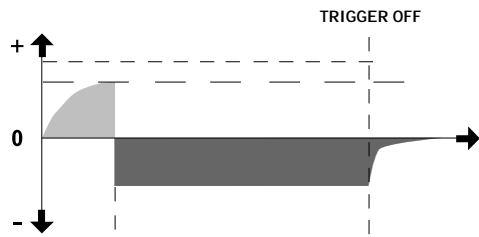

figure 22

SPEEDY ADSR

The ADSR speed can get up to 4 times faster. How ? Transmit MIDI control messages to the Filterbank that affect the Attack, Decay and Release speed. When the Filterbank is powered up, the ADSR speeds are initialised 1/4 of their maximal speed = control value 63. This is half of an exponential scale (see Fig. 27, page 46). So if this is your problem, just change that initial value to 0.

 No MIDI control of envelope modulation amount possible ?

Simply connect ADSR out to FM in and MIDI foot control will do the job. Even negative : send MIDI foot control half way (value 63) and anticipate that with the envelope amount knob(s) until no modulation is heard. Sending MIDI foot control above and under 63 will result in positive and negative modulation.

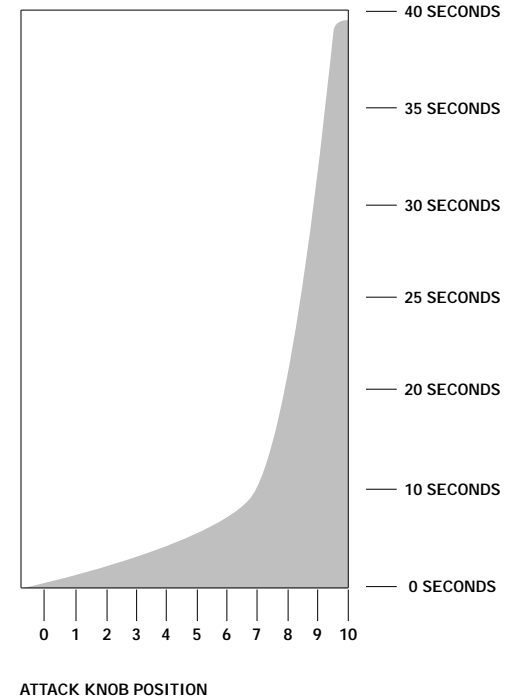

Attack time in function of knob position, when midi controller 5 (porta time) value is 63 (=default value). Not valid for envelope follower.

ENVELOPE FOLLOWER

A SENS. R = ATTACK SENSITIVITY RELEASE

An envelope follower basically creates an output voltage that follows the level of its input signal. (fig.23) Set the toggle switch to its downwards position. Now the ADSR generator becomes an envelope follower. Set attack and release to zero. Plug in a dynamic sound source, like a (bass) guitar, piano, organ with swell pedal, drum loop or any other device providing volume variations. Adjust sens in combination with the envelope modulation amount knobs of the filters, for good response. Watch the ADSR indication light, it should flash yellow when the envelope follower is active, weak red when there's no input signal. Try the envelope follower with different modulation amounts of filter 1 (filter 2 in sync). Repeat these exercises with filter 2 free running in parallel mode; experiment also with the envelope modulation amount knob of filter 2.

NOTE : The trigger input of the ADSR here becomes the envelope follower input. You can plug in another signal source in this input, and use its volume variations for filter modulation. Try it !

NOTE : Decay has no function in the envelope follower, and attack and release of the ADSR generator are not MIDI-controllable in envelope follower mode.

figure 23

HOW THE ENVELOPE FOLLOWER WORKS

HERE, IN ENVELOPE FOLLOWER MODE, DECAY IS NOT APPLICABLE. THE SUSTAIN KNOB FUNCTIONS AS SENSITIVITY.

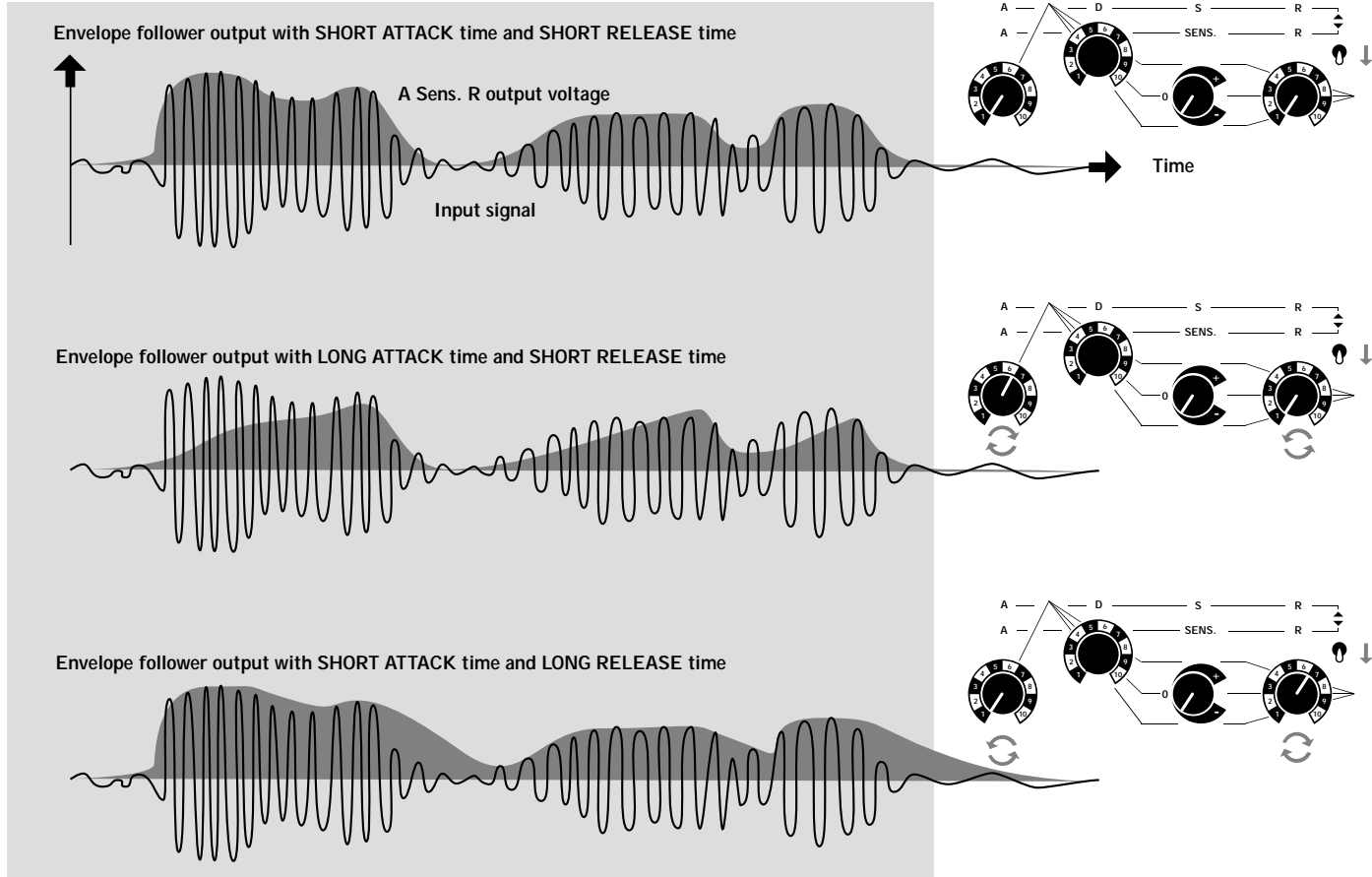

LESSON #7

FM

FREQUENCY MODULATION

FM equally modulates the frequencies of both filters. Set the knobs as shown in fig.14, page 25, but without ADSR modulation. Send a low monophonic tone to the FB. Increase the FM amount firmly and then turn it down slightly. Work with different sound sources like bass, organ, sawtooth and square wave. Check FM with different freq 1 settings and input levels. The reso settings also play an important role here. Now insert a jack cable in the FM input. You will notice that FM doesn't work internally anymore. Now you can try a different sound source with this input,

 e.g. take another synth or sampler output and experiment with this source playing the same melody as the processed melody, but now try different tuning intervals between input and FM source.

NOTE: The FM input also accepts DC voltages from e.g. a cv/gate output, a modular system's lfo or ADSR, the voltage output of any analog sequencer, any pedal or device that provides a variable voltage or signal output.

 You can use the FM amount knob as a common ADSR amount knob for both filters by connecting ADSR out to FM in.

 You can produce subharmonic FM as follows: Connect MAIN OUT to FM in. Route only OUT 1 to your sound system. Set both RESO controls to maximum. First try parallel mode, afterwards serial. Now try out different harmonics (also "free") with different FM amounts.

figure FM

THE PRINCIPLE OF FREQUENCY MODULATION

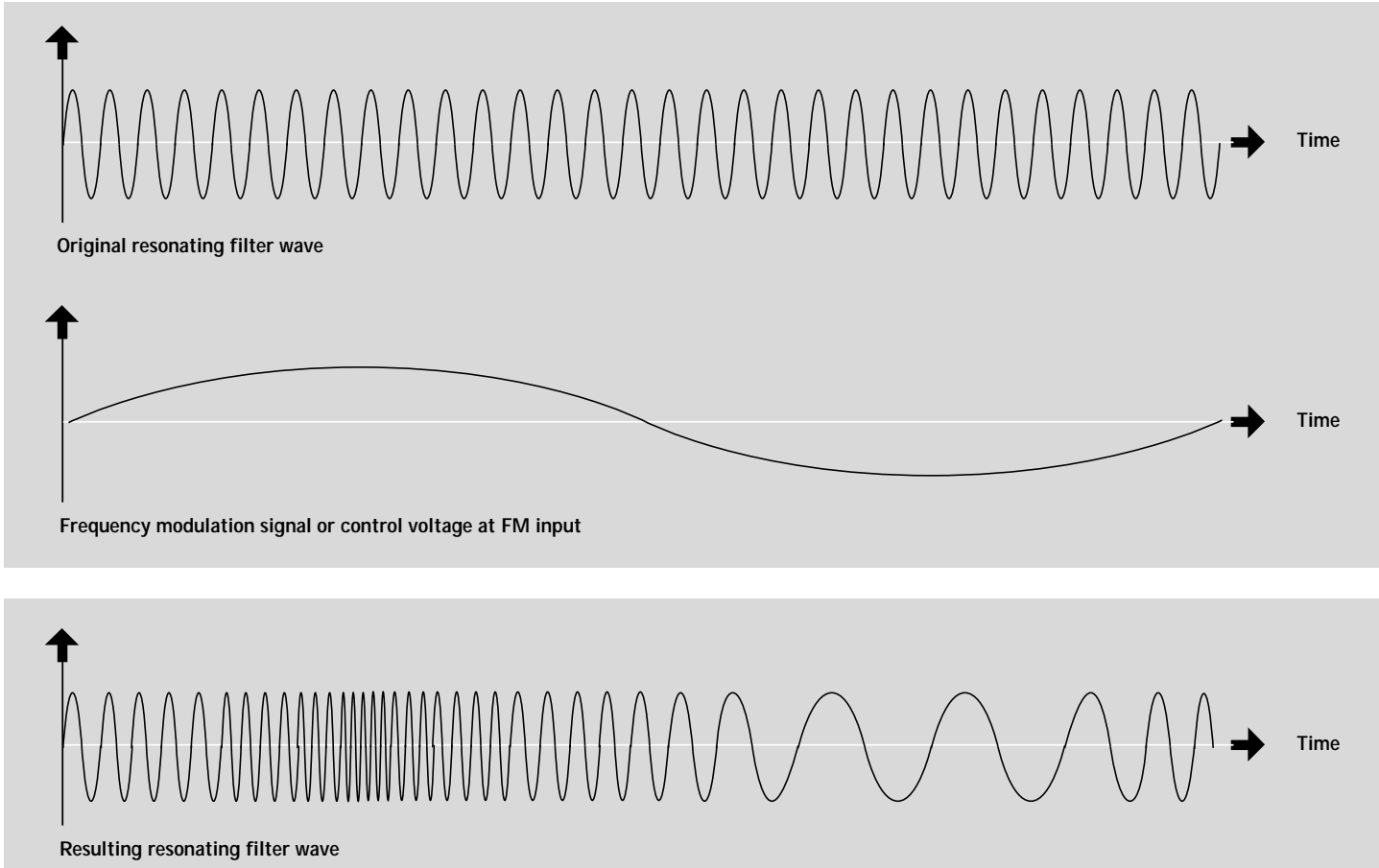

LESSON #8

AM

AMPLITUDE MODULATION

AM equally modulates both OUT 1 and MAIN OUT VCA's. AM modulation is the key to warm, fat and extremely aggressive sounds. Set the knobs as shown in fig.14, page 25, but without ADSR modulation. Send a monophonic sound to the input. Increase the AM amount firmly and then turn it down slightly. Work now with different pitches, sounds and input levels.

 Because this modulation is working on the VCA's, the AM signal is multiplied with the processed signal. Just as in maths, multiplication can make big numbers out of small ones, so mind your speakers. Also note that AR can be overruled by AM.

NOTE: when there is no jack plugged in the AM input, the output of filter 2 is used as an AM source, so reso 2 will have more influence than reso 1.

Now insert a jack cable in the AM input. You will notice that AM doesn't work internally anymore. Now you can try a different sound source with this input,  e.g. take another synth or sampler output and experiment with this source playing the same melody as the processed melody, but now try different tuning intervals between the input and AM source.

 You can use the ADSR envelope generator in addition to the AR generator for controlling output dynamics; simply connect the ADSR output to the AM input. Also this way, in envelope follower mode, you create an expander. An expander is the opposite of a compressor.

IMPORTANT : internal AM needs enough input signal & high reso setting of filter 2 to have significant effect. once familiar with the kind of effect, you can use it in a more subtle way.

figure AM

THE PRINCIPLE OF AMPLITUDE MODULATION

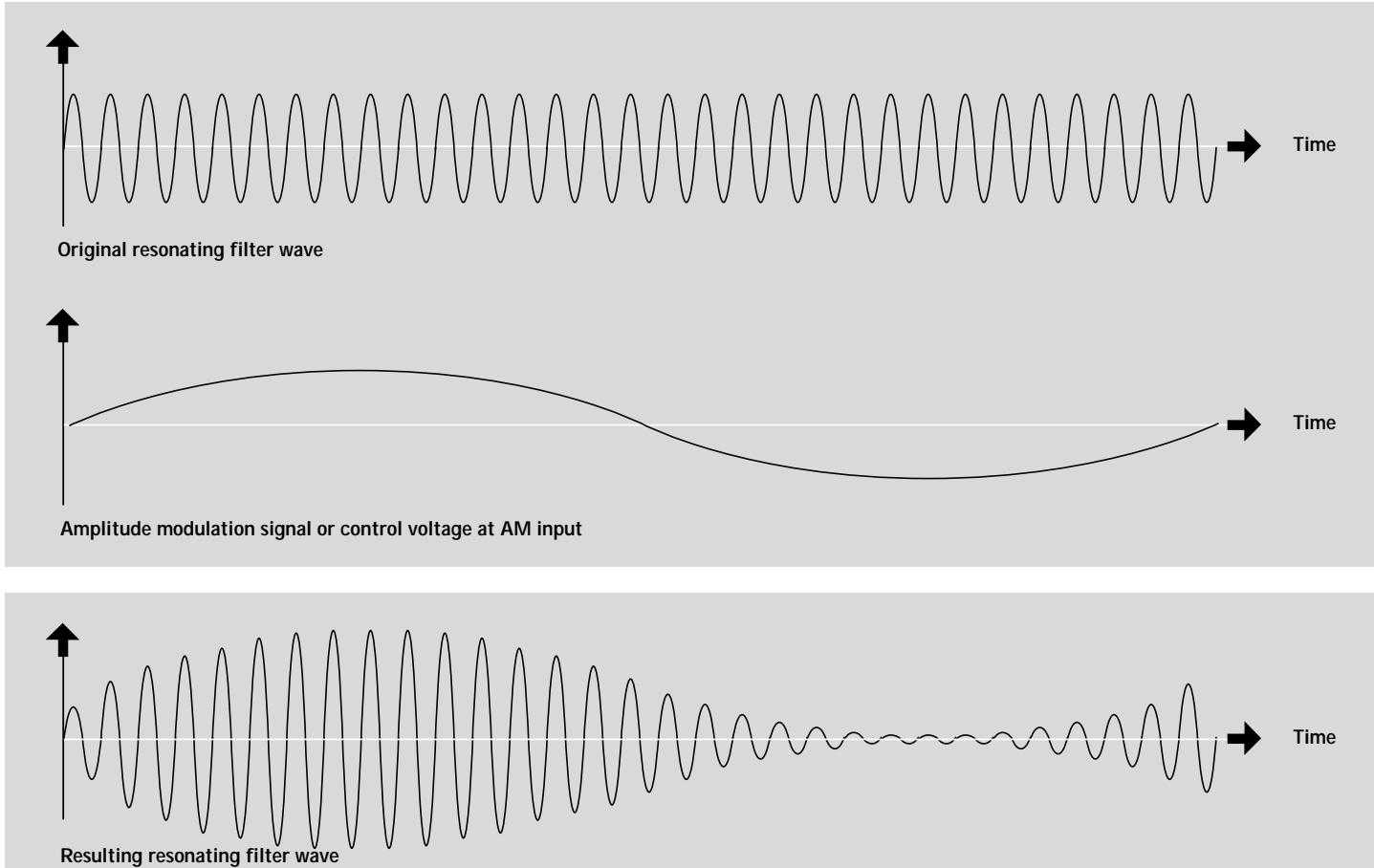

LESSON #9

TRANPOSE - TRACKING

TRACKING or Harmonic searcher. The 3-way switch  activates the really powerful and quite revolutionary "Tracking" function a monophonic pitch follower, that tunes filter 2 to the incoming pitch, and makes filter 1 slave of filter 2 via the harmonics switch. E.g. in position 2, filter 1 will be pitched one octave higher than filter 2, but still following the pitch.

This switch activates the "tracking" in a normal or deep "track low" position, with stunning basses as result. Please note that tracking is not quick enough to handle supersonic guitar solo's, therefore we advice " + quint", which has no latency at all !

Open the FM knob a bit to activate " tracking" and " +quint", and adjust FM to get the best tracking.

You can over-modulate tracking with all frequency controls, so we advice strongly to start off with freq.1 on minimum, and later to search overtones by " overmodulating" the tracking.

A white LED indicates when the tracking system is " locked on".

The 3-way switch  has 2 general transpose functions : +1 Octave and + Quint and has a specific dirty character. + Quint works only with pure monophonic signals. Open the FM knob a bit to activate " + Quint". It works like a kind of octaving submodulation.

 Tracking works only with clean notes ? Yes if you want clean tracking. With more complex signals, tracking will keep searching for the most explicit harmonics, and this can be useful when you put the reso's low. This way the "unstable" tracking will generate a random cutoff in the neighbourhood of the dominant harmonics of the incoming signal. Smells like grunge... schht !

 Your good ol' original filterbank can also make use of tracking, just link it up to the FB2.

figure TRACKING

EXAMPLE OF USING "TRACKING"

**EXTERNAL
SOUND TO
PROCESS**

**MONOPHONIC KEYBOARD
TO PLAY THE DESIRED FILTER PITCH**
THE LOUDER THE FILTER RESONANCE COMING FROM THIS KEYBOARD,
THE MORE LIKELY TRACKING IS GOING TO FOLLOW THAT FILTER.

OUT

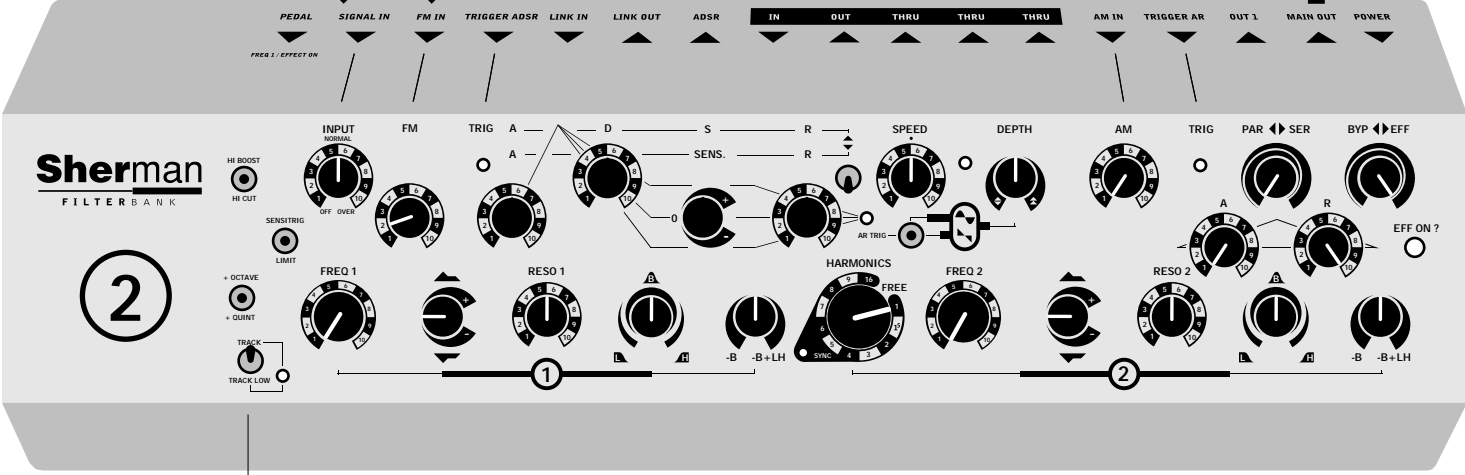

TRACKING ON

LESSON #10

EXTERNAL INPUTS - PEDAL

Take a look at fig.24 for an overview of the internal routings. practice lesson FM, AM, ADSR and AR with a second signal source connected to the relevant input. Make sure this signal is strong enough to make the triggers work (lesson 5 & 6), or to hear sufficient modulation (lesson 7 & 8). For the triggers (lesson 5 & 6) a drum machine should do the job. For AM and FM, any line level signal e.g. a synth, sampler or headphone output is ok, a microphone to weak.

If you want the triggers to work very fast, use very short input pulses or sound bursts. Note that the trigger inputs also work with gate signals from e.g. a CV/Gate output.

 You can make a jack connection from the ADSR out to the AR trigger in. When the ADSR has a slow attack, the AR trigger will be delayed. The amount of this delay depends on the attack time.

For the FM & AM inputs an organ or bass signal is excellent. Note that these inputs also work with DC signals, e.g. an external LFO, ADSR, CV...

Don't be afraid to try different external connections, the inputs can cope with a lot. You may also short circuit (= join with a jack splitter) two outputs of 1 or more filterbanks, if you want e.g. mix two filterbanks, or ADSR out with the audio OUT 1 to AM in...

 However, this doesn't mean that YOU can, so don't even think about making any kind of direct connection with dangerous voltage sources like tube amp speaker outputs, tv sets, ac mains, power plants, toasters, lightning rods or ufo's...

The pedal input (we will deliver a footpedal separately) allows foot control of Freq 1 and Bypass / Effect switching. This footpedal will also be especially designed by Sherman. For now, any regular footswitch will do for Bypass/Effect switching. Effect on is indicated by the big green LED right on front.

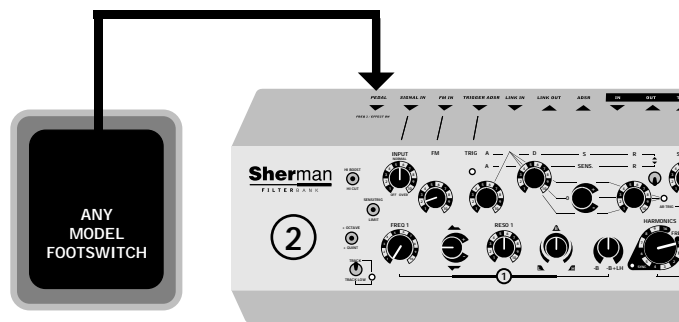
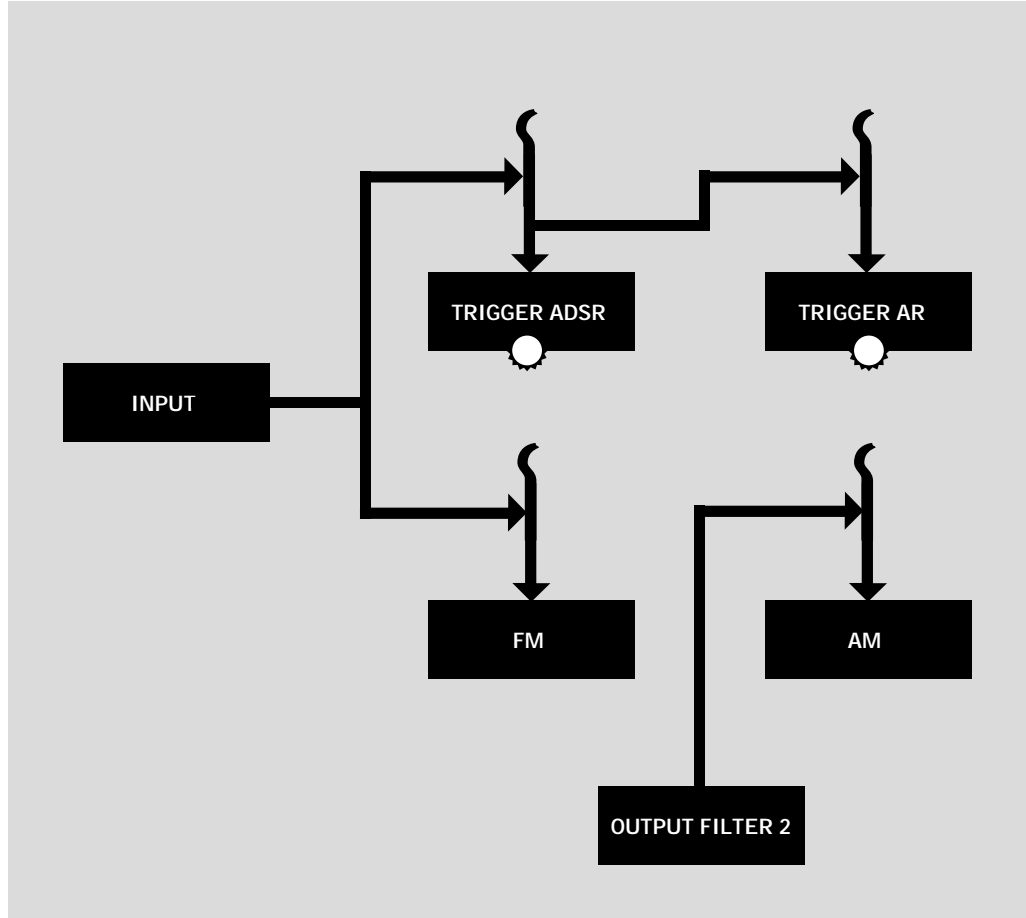
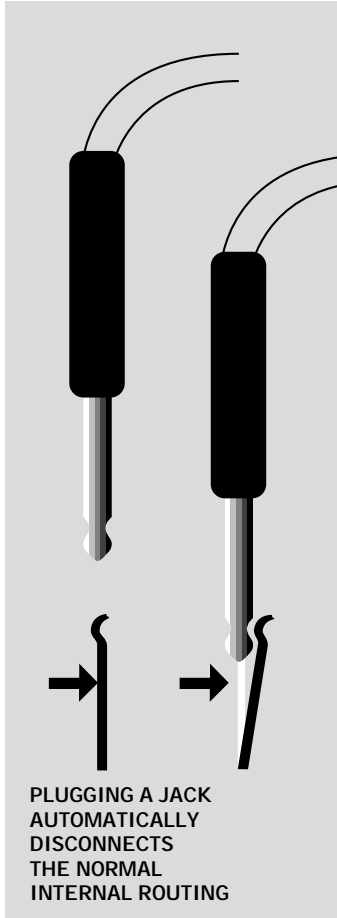

figure 24

INTERNAL ROUTING OF THE JACKS



LESSON #11

MIDI

The basic power-on channel is always 16. You can change the receive channel by sending a program change (any number) on the actual channel (16 on power-up). The channel on which the first following MIDI message (any type) is sent becomes the new receive channel. The MIDI out channel always remains 16. If you have two or more FB's in the SAME MIDI chain and you want to assign different receive channels to them, proceed as follows : power on the first FB in the MIDI chain. Change it's receive channel. Power on the next FB in the chain. Change it's receive channel, and so on... The last in chain, you can leave at channel 16.

(*)  The modulation wheel is also used for a special function : in sync mode, when set to 127, it pitches the whole machine exactly one octave up! Try this out with high reso settings, this octave switching can be musically very interesting. It makes the FB operate in ultra high frequency ranges, so mind your tweeters. Leave the modulation wheel on 0, if you don't use it, values between 0 and 127 can cause strange things in sync mode.

(**) Unknown control 5 = porta speed.

See also figs. 27, 28 and 29 for the influence of MIDI on the attack speed of ADSR. A similar effect applies to decay and release timings.

MIDI IN

First, get familiar with the controllers :

MIDI MESSAGE	FILTER BANK FUNCTION	POWER-UP VALUES
Pitch wheel (fig.25)	Cutoff freq filter 1 <small>(fine resolution)</small>	4096 (zero)
Channel pressure (fig.26)	Resonance filter 1	0
Modulation wheel(*)	Cutoff freq filter 2	0
Breath control	Resonance filter 2	0
Foot control	FM depth	0
Main volume	VCA bias	127
Expression	AM/ring depth	0
Unknown Control 5(**)	Attack time ADSR	63
U.C. 16	Decay time ADSR	63
U.C. 17	Release time ADSR	63
U.C. 18	Attack time AR	63
U.C. 19	Release time AR	63

figure 25

WHAT HAPPENS WHEN MIDI CONTROLS COME IN

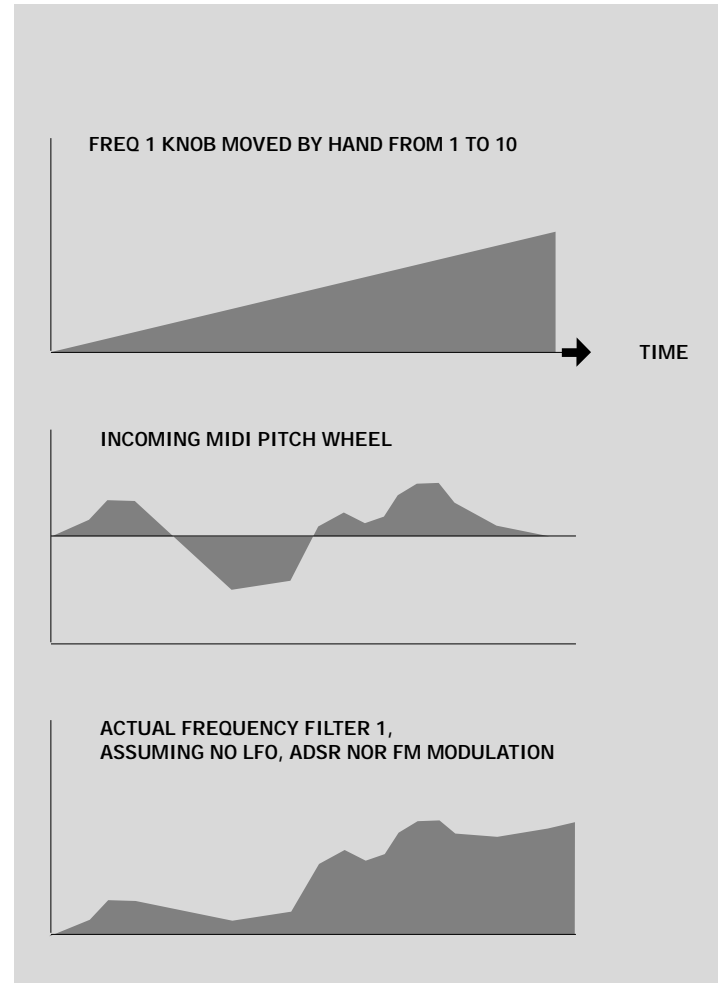
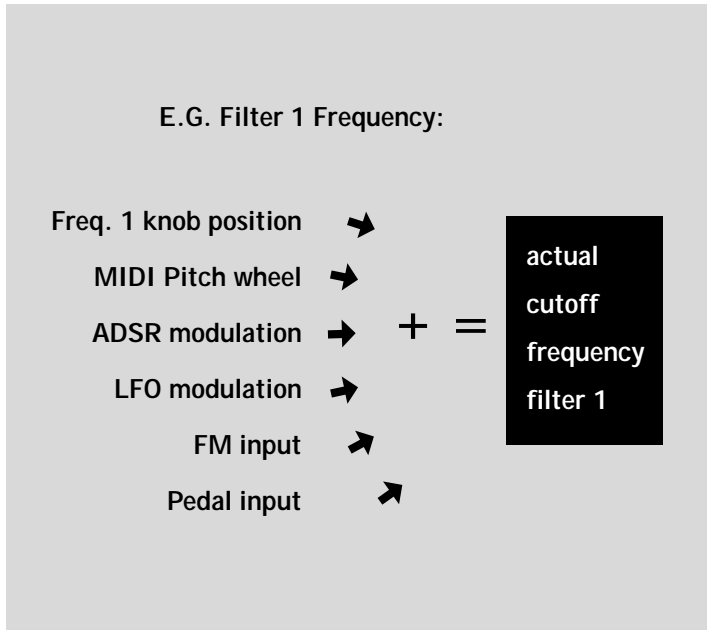

figure 28

This is an example of how the attack time of the ADSR can be speeded up and slowed down while it's running.

You can do similar on-the-fly time changes with the decay, release and attack release of the AR generator too.

In these examples MIDI controller 5 is drawn in a sequence program.

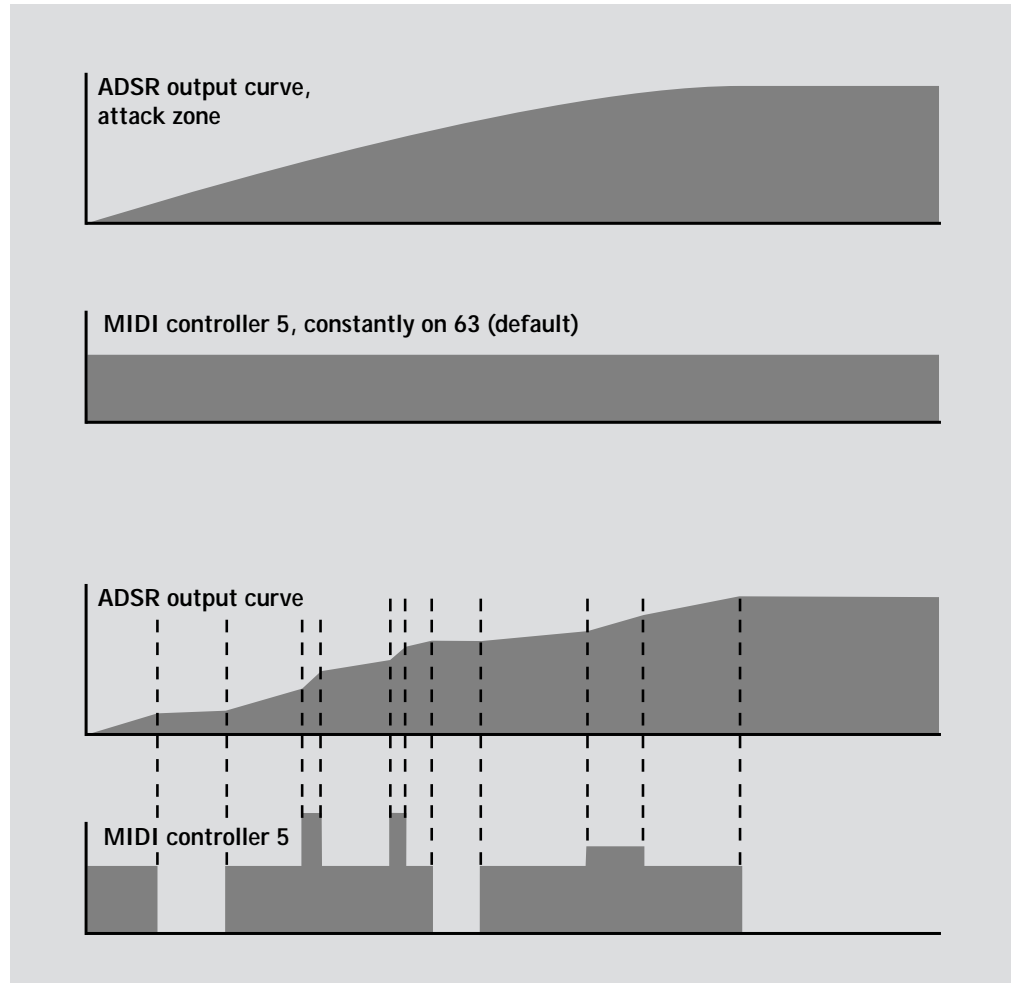
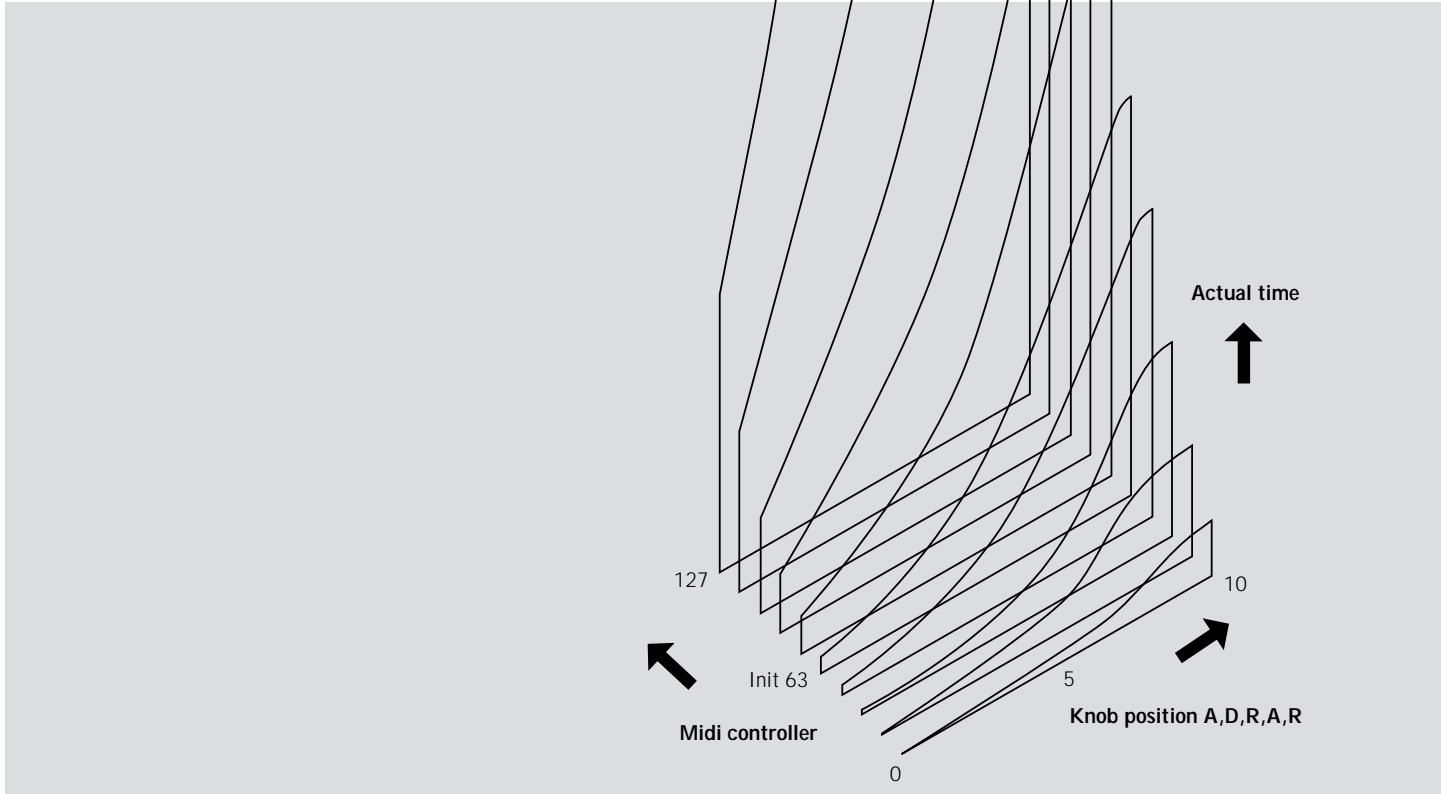



figure 29

3D VIEW OF THE RELATION TIME - KNOB SETTING - MIDI CONTROL



Try now to make a melody with pitch wheel. Set the knobs as in the figure shown below. Set freq 1 to an acceptable start note for the desired melody. Now draw or give in (e.g. in sequencer grid edit) zero (middle) pitch wheel modulation on the start time. Now draw the second note, on a later time, and let one bar loop to hear the pitch variation. Now adjust pitch of the second "note" e.g. in grid edit, changing VALUE 1 AND 2. A MIDI pitch wheel message consists of two 7 bit bytes, one for coarse and one for fine tune. Only when the second note is in tune, you may build further your melody. Leave the Freq 1 knob in its original position, it could change the tuning intervals.



 Tip for producers: once you have "tuned" the filters this way, bring down the resonances and filter instruments in your mix to make them resonate along with the music in a subtle way! It gets even more interesting in parallel, with different harmonic switch settings. Link up (lesson 11) a second FB for stereo processing or more harmonic intervals.

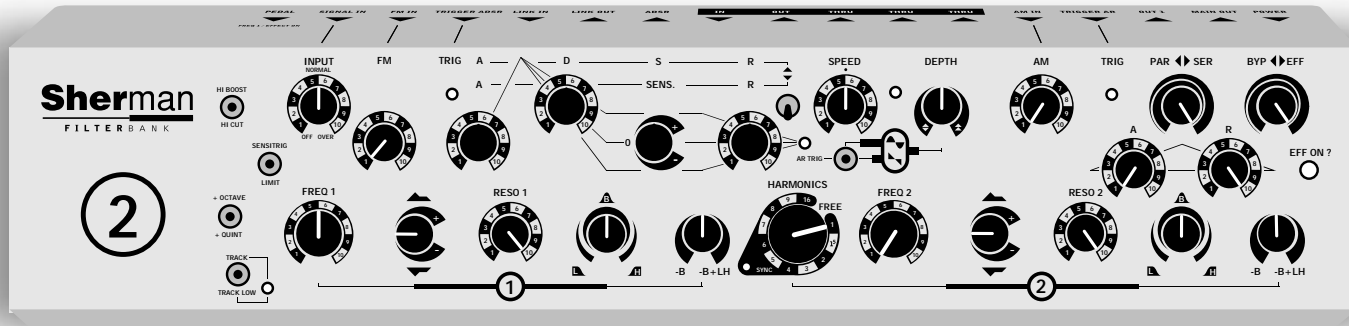

TRIGGERING

If you want triggering to happen exclusively via MIDI, you can block the audio triggering. There are two software toggle switches in the FB. Their function is to block the AR and ADSR audio trigger sensitivity (so that MIDI triggering does not interfere with triggering by the audio signal). You can toggle these switches by sending the following MIDI note messages:

C4 : unblock audio trigger ADSR
C#4 : block audio trigger ADSR
D4 : unblock audio trigger AR
D#4: block audio trigger AR

Power-up unblocks the audio triggers.

The actual MIDI triggering is done by sending following MIDI notes:

F#4: normal trigger ADSR
A#4: normal trigger AR
G#4: normal trigger both
F4: trigger ADSR with speeded-up (*) attack
G4: forced gate-off ADSR with speeded-up (*) release
A4: trigger AR with speeded-up (*) attack
B4: forced gate-off AR with speeded-up (*) release

figure 30

MIDI TRIGGER NOTES

Plug in the MIDI out of a keyboard to the MIDI in of the FB, set the transmit channel of the keyboard to 16, and play the triggers from the keyboard.

Forced gate off AR, speeded up release
Normal trigger AR
Trigger AR, speeded up attack
Normal trigger both
Forced gate off ADSR, speeded up release
Normal trigger ADSR
Trigger ADSR, speeded up attack
Block audio trigger AR
Unblock audio trigger AR
Block audio trigger ADSR
Unblock audio trigger ADSR

C4

(*)MIDI time = zero

The actual time is calculated by multiplying the setting of the knob with its MIDI controller value (3D view fig.29). When it says "speeded-up", the actual MIDI control value (=63 when powered up) is TEMPORARILY set to zero.

E.G. PLAYING FADE-IN'S ON THE KEYBOARD

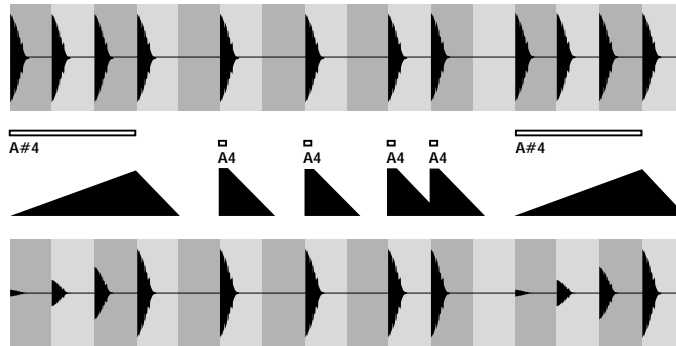

If you set the attack time knob of the AR to almost zero and send a high attack time value via MIDI, you can program the following in your sequencer: send note A#4 a few seconds before the start of the beat, so that the volume of the FB reaches its maximum just on the start, and use note A4 for quick attacks and speedy percussions in the song. Then use note A#4 again in a break, etc.

NOTE : For very fast triggering: same story as for audio triggering: use very short notes because, once triggered, a trigger light will remain on for a short while.

MIDI OUT

Trigger light action is always sent to the MIDI OUT port as normal trigger notes on channel 16, whatever the source (audio or MIDI). This is useful for recording with a sequencer. Only F#4 and A#4 are sent out.

 E.g. the audio triggering of a drum loop can be recorded via MIDI out, and these patterns can then be used with another audio signal by feeding back the recorded notes in the FB's MIDI in. Don't forget to block the audio sensitivity. Add some pre-delay with AR attack to obtain a sucking gate effect.

Note : This is the only thing that is sent out.

MIDI THRU

The FB is equipped with 3 MIDI thru ports. They act like a normal MIDI thru box with the MIDI in.

 Note: If you experience MIDI problems, do not panic right away. Test the unit by connecting the MIDI out of a synth directly to the MIDI in of the FB. Check the pitch wheel response of the cutoff frequency filter 1 and find the MIDI trigger notes. Avoid MIDI loops and too many devices in one MIDI chain. Some may give bad MIDI thru! Avoid too long MIDI cables.

LESSON #12 LINKING MORE FILTERBANKS

You can chain the FB's endlessly with the link Input / Output specially provided for this purpose. (fig.31) The first (master FB) in the chain's filter 1 will act as master over the filter 1 of all the slaves. Filter 2 of each FB will act as always : free or in sync with Freq 1 (of the master in this case). Try out different harmonic switch settings on the FB's in the chain to form chord intervals.

- ⚠ Avoid using too long jack-jack cables for this.
- 👉 Check the last part of the video on www.sherman.be !

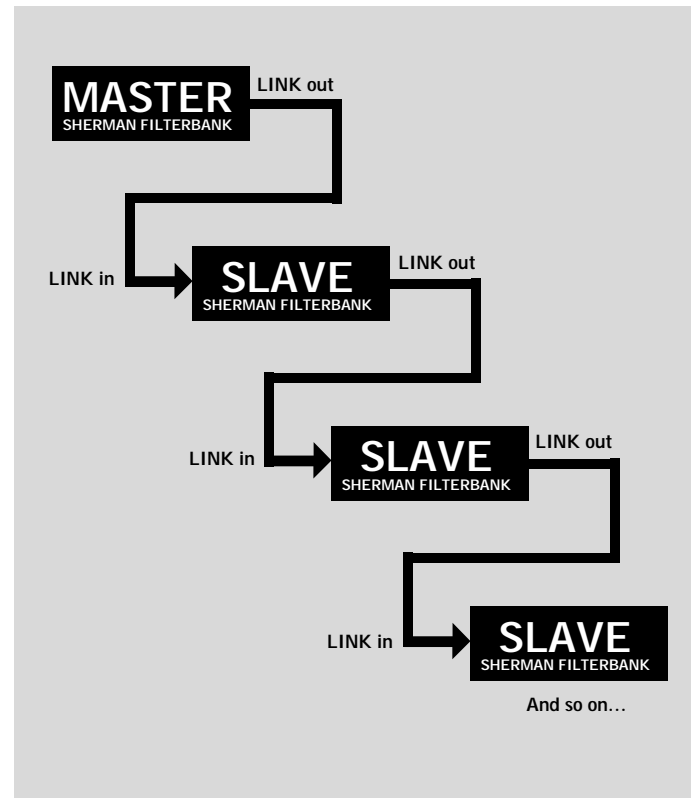

MAKE A VERY NEAT

48db FILTER :

figure 32

Set up two FB's. Connect the MAIN OUT of the first to the input of the second. Make a LINK connection and set the knobs of both FB's as shown in fig.32. Set up a third FB, linked in serial mode and with the same settings, and your 72 db filter is ready. You can even make a similar stereo, triple or quadrophonic setup etc.

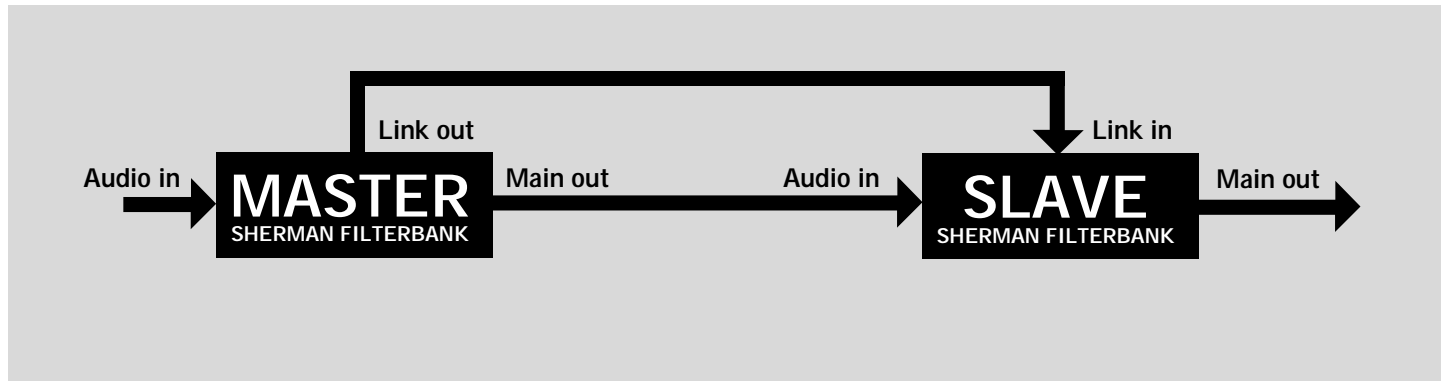
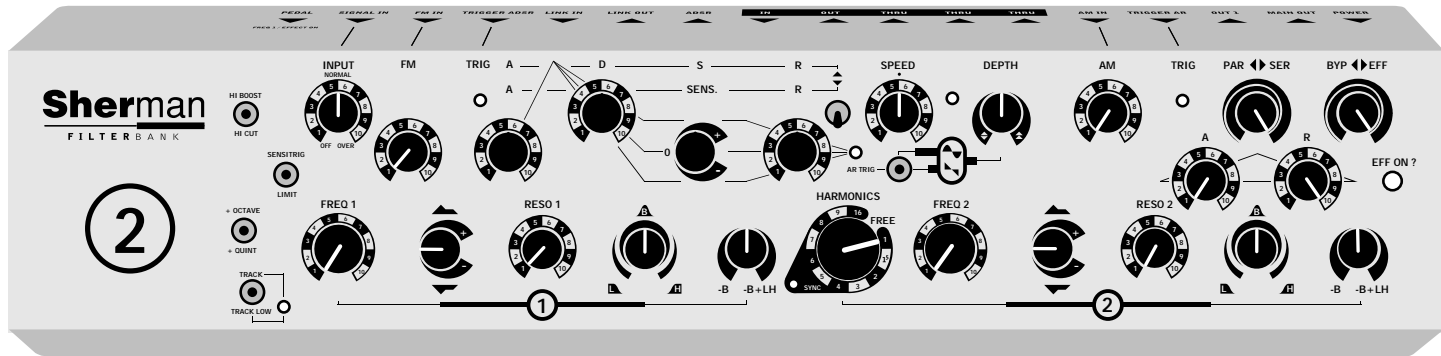



HISTORY & PHILOSOPHY

I'm not an engineer. I play guitar for 20 years now, but fiddle with electronics for 25 years. 18 years ago I built a modular system for use on guitar, because I was not satisfied with the overdrive behaviour of most transistor-based gear. I looked at Marshall amps and studied how they achieved that warm sound, measured their curves and frequency responses.

I made over a hundred dance records in the late eighties, pioneered with the use of drumloops. All the time I built gear for myself like e.g. a short MIDI delay to bypass the delay of my louzy prophet 3000 operating system, tube preamps to overdrive synth sounds, compressors & noise gates to use on a spring reverb, a programable bunch of guitar pedals, an air scratcher ... at that time you couldn't buy those things at reasonable prices. Once I made a sampler of an apple II by swapping it's memory with an Ibanez delay. 7 years ago I decided to use all my experience and started to design a commercial manufacturable modular synth with mouse drawn envelope curves, Moog filters, a complex modulation matrix and a real time mouse drawable arpeggiator sequencer. That monster is still not ready and probably never will be. Because many people asked me for, I started to make a filter box, which i equipped with all the functions I would like as a musician, not just another Curtis chip based box with one lowpass filter and a reso knob. No, I wanted something much more powerful than anything on the market, but for a reasonable price. The first model of the Sherman was hand built, but after 40 pcs I realised that it was too difficult to keep building that by hand.

So I developed the Filterbank like it is now : smaller with SMD (surface mount device) components, easy to assemble by a machine, cheaper because of less printboard space use, but more functions, MIDI controllable, but still analog.

Although it is small, it contains more parts than say: a Minimoog, thanks to this SMD technology. Electronically seen is a discrete resistor the same as an SMD resistor, the SMD is 10 times smaller. Most manufacturers use DSP (digital signal processing) now, because it's so cheap to develop. To make a filter, they just have to implement a formula in the DSP. A DSP based machine sounds too perfect and has too low dynamics to equal analog gear in power & liveness. Digital processing generally has the disadvantage of losing information in the process of digitizing and calculating. With DSP overdrive simulation, you can just reach the limit of your 64 bit number. So, overdrive must be programmed, but still sounds dead.

Why ? A car crash is always different, in the same circumstances, on the contrary, a computer simulated car crash is always the same. That's why real analog sounds more "live" than a bunch of routines trying to simulate analog circuits.

Thanks to noise, crossover distortion and influence on power fluctuations, temperature, aging pot's, all those things that we tried to avoid, an analog gear has character. A 909 bassdrum is never the same, because there is a small analog synth in the 909, generating the bassdrum. A sampled 909 bassdrum has never the punch of the real. Why ? D/A converters are limited in frequency response and dynamics. Fortunately, some manufacturers, such as Studio Electronics, Tube Tech, Jomox ... stay in to analog, which - unfortunately- costs a lot more, because every circuit has to be tested and adjusted. The Sherman FB is such gear, but I think it has a fair price for its features.

Herman Gillis, designer

Special thanks to the following people for supporting me all the way; my wonderful partner Mieke Frère, Joel Cordier, Daan Stuyven, Luk Page, The staff & artists of R&S records, and last but not least : all abusers.

TROUBLESHOOTING

99% of all broken Sherman Filterbanks are due to bad potentiometers. Please take the effort of measuring all pots of the FB, before sending back the whole inner board for repair. Anyone who has a bit experience with soldering can replace a pot. There are different 3 types of pots in the filterbank.

20 K (Twenty thousand Ohm)

FM, AM, FREQ1 & FREQ2

1 M (One million Ohm)

A, D, R, A, R, RES01, RES02

100K Dual (Hundred thousand Ohm) with middle click

LFO SPEED, LFO DEPTH, INPUT LEVEL, SUSTAIN, PAR/SER, BYP/EFF, L-B-H 1, CORR1, L-B-H 2, CORR2, ADSR DEPTH 1, ADSR DEPTH 2

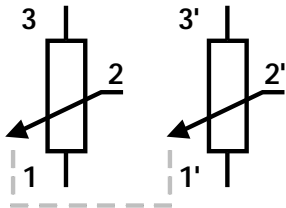

Take a simple Ohmmeter, put the potmeter to test (yes, while it is mounted in the Filterbank) in middle position. E.G. Measure the resistance between PIN 2 and 1 of a 100K pot. If the resistance is a lot more than 50K Ohm, then the pot is certainly BAD. BECAUSE a 100K LINEAR POT in middle position should measure around 50K. In full CCW (counter clock wise) position, you should measure maximal 40 Ohms between pin 1 & 2 and between pin 1' and 2'.

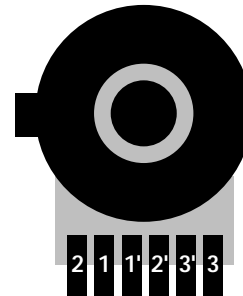

TOP VIEW

In case you have / find facilities to do the repairing, please contact us for spare parts; info@sherman.be

MEMORY NOTATION SHEET MULTIPLY / COPY THIS PAGE FOR UNLIMITED USE!

SOUND NAME:

Sherman
FILTER BANK

②

1 2

SOUND NAME:

Sherman
FILTER BANK

②

1 2

SOUND NAME:

Sherman
FILTER BANK

②

1 2

EXAMPLE SETTINGS

VARIABLE BAND WIDTH

(only main out)

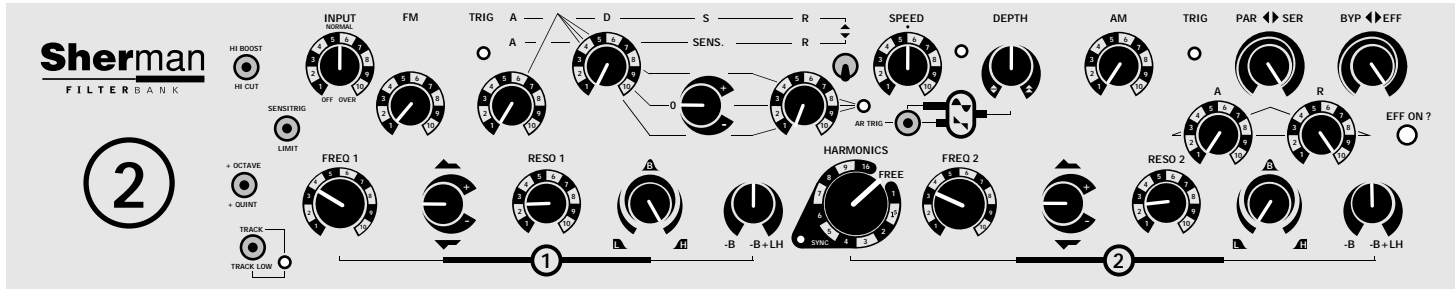

PHASING 1 "VARIABLE GAP"

(only main out)

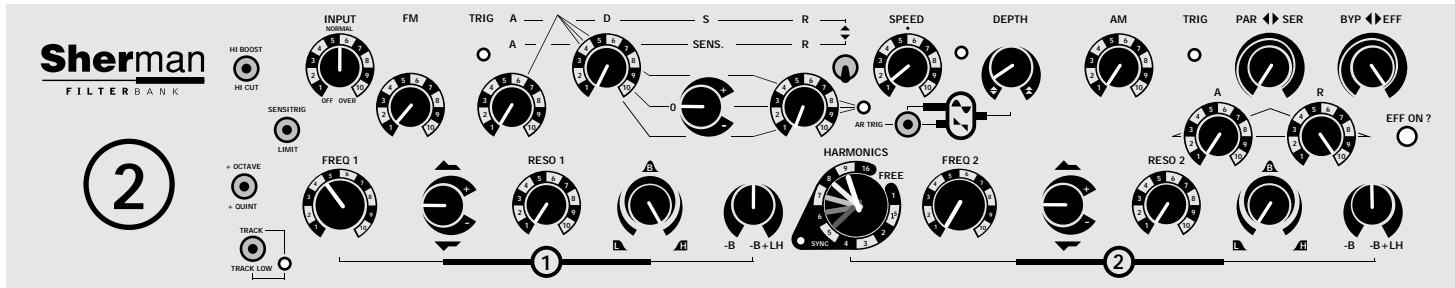

PHASING 2 "TWO NOTCH DIP'S"

(only main out)

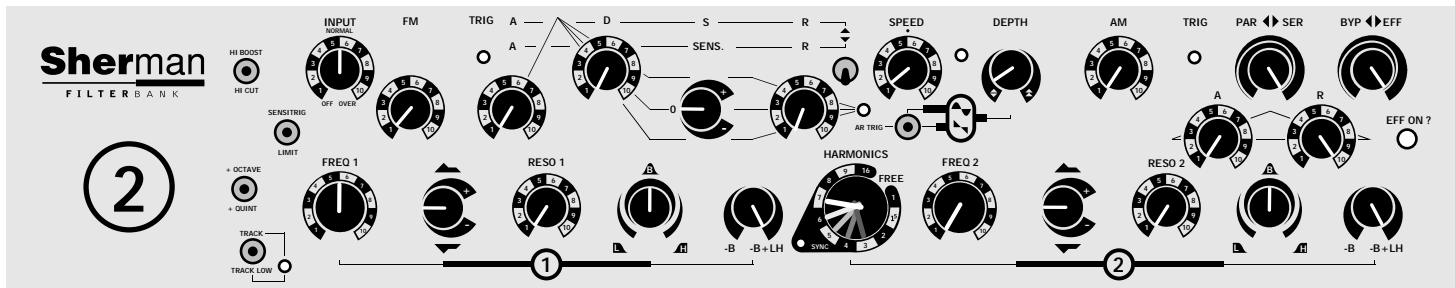

EXAMPLE SETTINGS

FORMANT VOCAL

(only main out)

The Sherman Filter Bank control panel for Formant Vocal settings includes the following parameters and their approximate values:

- HI BOOST:** 0
- HI CUT:** 0
- SENSISTRING:** 0
- LIMIT:** 0
- INPUT:** NORMAL
- FM:** 10
- TRIG:** 0
- A:** 10
- D:** 10
- S:** 10
- R:** 10
- SENS.:** 10
- SPEED:** 10
- DEPTH:** 10
- AM:** 10
- TRIG:** 0
- PAR:** 10
- SER:** 10
- BYP:** 10
- EFF:** 10
- FREQ 1:** 10
- RESO 1:** 10
- HARMONICS:** 10
- FREQ 2:** 10
- RESO 2:** 10
- TRACK LOW:** 0

Additional controls include OCTAVE, QUINT, TRACK, and various filter parameters like A, B, B+LH, and SYNC.

BASSDRUM - RANDOM BASS LINE

(only main out)

The Sherman Filter Bank control panel for Bass Drum - Random Bass Line settings includes the following parameters and their approximate values:

- HI BOOST:** 0
- HI CUT:** 0
- SENSISTRING:** 0
- LIMIT:** 0
- INPUT:** NORMAL
- FM:** 10
- TRIG:** 0
- A:** 10
- D:** 10
- S:** 10
- R:** 10
- SENS.:** 10
- SPEED:** 10
- DEPTH:** 10
- AM:** 10
- TRIG:** 0
- PAR:** 10
- SER:** 10
- BYP:** 10
- EFF:** 10
- FREQ 1:** 10
- RESO 1:** 10
- HARMONICS:** 10
- FREQ 2:** 10
- RESO 2:** 10
- TRACK LOW:** 0

Additional controls include OCTAVE, QUINT, TRACK, and various filter parameters like A, B, B+LH, and SYNC.

SYNCOSSION

(only main out)

The Sherman Filter Bank control panel for SyncoSSION settings includes the following parameters and their approximate values:

- HI BOOST:** 0
- HI CUT:** 0
- SENSISTRING:** 0
- LIMIT:** 0
- INPUT:** NORMAL
- FM:** 10
- TRIG:** 0
- A:** 10
- D:** 10
- S:** 10
- R:** 10
- SENS.:** 10
- SPEED:** 10
- DEPTH:** 10
- AM:** 10
- TRIG:** 0
- PAR:** 10
- SER:** 10
- BYP:** 10
- EFF:** 10
- FREQ 1:** 10
- RESO 1:** 10
- HARMONICS:** 10
- FREQ 2:** 10
- RESO 2:** 10
- TRACK LOW:** 0

Additional controls include OCTAVE, QUINT, TRACK, and various filter parameters like A, B, B+LH, and SYNC.

INDEX

Adapter.....	2	MIDI out.....	51
ADSR.....	24	MIDI resonance.....	46
AM.....	38	MIDI panic.....	51
AR.....	22	MIDI pitch wheel.....	45
Audio trigger.....	9	MIDI time control.....	46
Block-unblock audio trigger.....	50	MIDI trigger	50
BYPASS< >EFFECT.....	6	No output?	17
Correction knob.....	11	Notch filter	8
Envelope follower.....	34	Octave switching via MIDI	44
External inputs.....	43	OUT 1	15
FM.....	36	Overview	back cover
Harmonic switch.....	12	PARALLEL< >SERIAL.....	15
History & philospky.....	52	Phasing	18
Index	Are you serious ?	Rack mounting.....	7
Introduction.....	4	Resonating melody.....	47
Lp-Bp-Hp	11	Second LFO	24
LFO.....	20	Setting examples	58
Link system.....	50	Sync (ZZZZe blue ZZZled).....	13
Main out.....	15	Tb 303 tip.....	22
Memory notation sheets.....	57	Tracking	40
MIDI.....	44	Troubleshooting	56

© SHERMAN PRODUCTIONS

STATIONSWIJK 73, B-3272 TESTELT, BELGIUM. - WWW.SHERMAN.BE - EMAIL: INFO@SHERMAN.BE

DESIGNED & DEVELOPED BY HERMAN GILLIS

VISUALS & LAYOUT BY DAAN STUYVEN